

PicoScope[®] 6000E Series

A smarter scope for faster debug

Deep-memory, high-performance oscilloscopes and MSOs



- 8-bit to 12-bit FlexRes[®] ADC
- A choice of 4 or 8 analog channels
- Add 8 or 16 digital MSO channels
- Up to 500 MHz bandwidth
- 200 ms capture time at 5 GS/s
- Up to 4 GS capture memory
- 50 MHz 200 MS/s 14-bit AWG
- 300 000 waveforms per second update rate

- PicoScope 6 software and PicoSDK included
- 21 serial protocol decoder / analyzers included
- Mask limit testing and user-definable alarms
- High-resolution time-stamping of waveforms
- Over ten million DeepMeasure[™] results per acquisition
- Advanced triggers: edge, window, pulse width, window pulse width, level dropout, window dropout, interval, runt and logic

Product overview

The PicoScope 6000E Series fixed-resolution and FlexRes oscilloscopes provide 8 to 12 bits of vertical resolution, with up to 500 MHz bandwidth and 5 GS/s sampling rate. Models with four or eight analog channels have the timing and amplitude resolution you need to reveal signal integrity issues such as timing errors, glitches, dropouts, crosstalk and metastability issues.

Typical applications

These oscilloscopes are ideal for design engineers working with high-performance embedded systems, signal processing, power electronics, mechatronics and automotive designs, and for researchers and scientists working on multi-channel high-performance experiments in physics labs, particle accelerators and similar facilities.

Best-in-class bandwidth, sampling rate and memory depth

Capture time at maximum sampling rate: 200 ms at 5 GS/s

With up to 500 MHz analog bandwidth complemented by a real-time sampling rate of 5 GS/s, the PicoScope 6000E Series scopes can display single-shot pulses with 200 ps time resolution.

The PicoScope 6000E Series gives you the deepest capture memory available as standard on any oscilloscope at any price – up to 4 GS in total.

This ultra-deep memory allows the oscilloscope to capture 200 ms waveforms at its maximum sampling rate of 5 GS/s.

The SuperSpeed USB 3.0 interface and hardware acceleration ensure that the display is smooth and responsive even with long captures.

The PicoScope 6000E Series gives you the waveform memory, resolution and analysis tools that you need to perform stringent testing of today's high-performance embedded computers and next-generation embedded system designs.

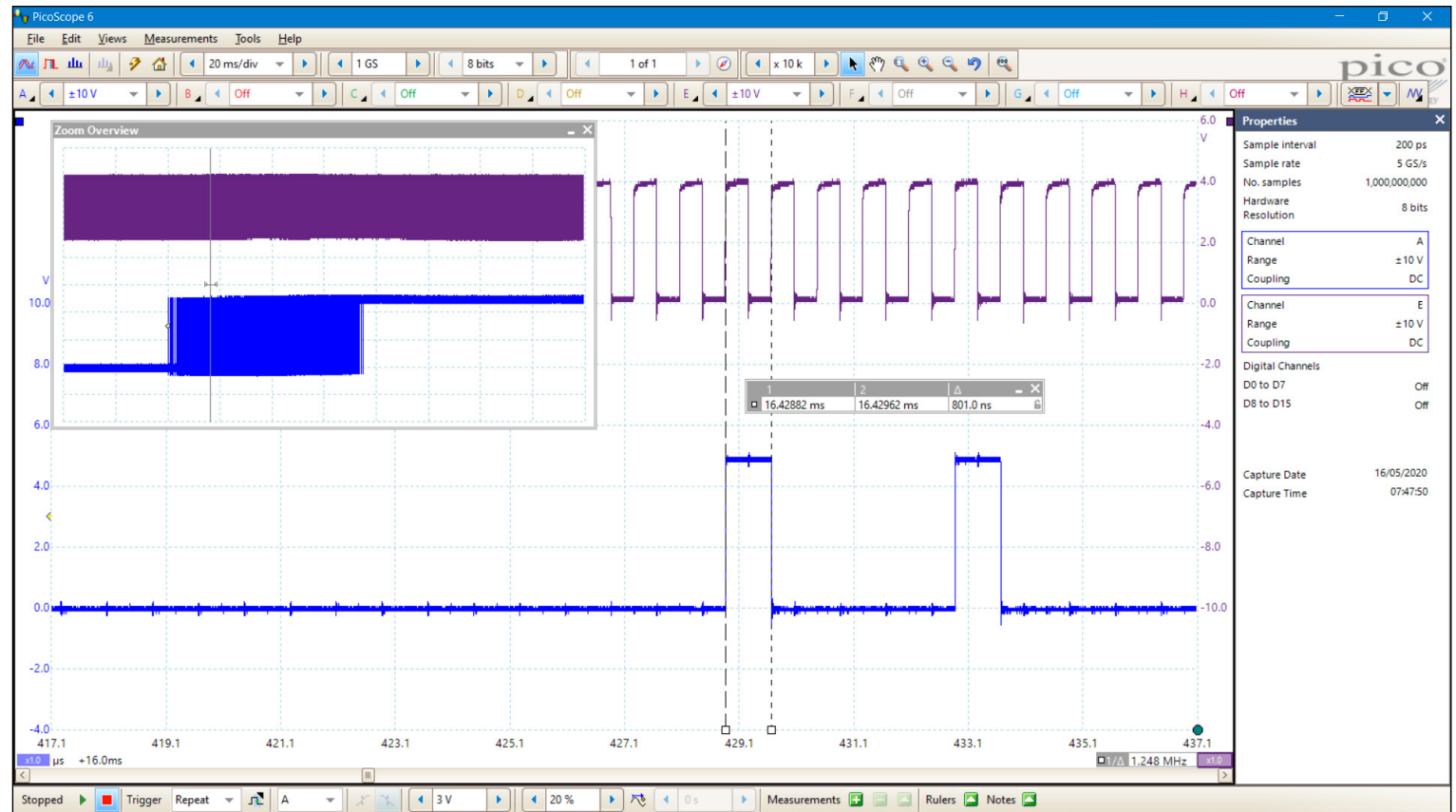

Power, portability and performance

Traditional benchtop mixed-signal oscilloscopes take up a lot of bench space, and models with eight analog channels are prohibitively expensive for many engineers working on next-generation designs. PicoScope 6000E Series oscilloscopes are small and portable while offering the high-performance specifications required by engineers in the lab or on the move, and deliver lowest cost of ownership for this class of instrument.

The PicoScope 6000E Series offers up to 8 analog channels, plus an optional 8 or 16 digital channels with the plug-in 8-channel TA369 MSO (mixed-signal oscilloscope) pods. The flexible high-resolution display options enable you to view and analyze each signal in detail.

Supported by PicoScope 6 software, these devices offer an ideal, cost-effective package for many applications, including design, research, test, education, service, and repair. PicoScope 6 is included in the price of your scope, available for free download, with free updates, and can be installed on as many PCs as you want, allowing you to view/analyze data off-line without the scope.



What is FlexRes?

Pico FlexRes flexible-resolution oscilloscopes allow you to reconfigure the scope hardware to optimize either the sampling rate or the resolution.

This means you can reconfigure the hardware to be either a fast (5 GS/s) 8-bit oscilloscope for looking at digital signals, a 10-bit oscilloscope for general-purpose use or a high-resolution 12-bit oscilloscope for audio work and other analog applications.

Whether you're capturing and decoding fast digital signals or looking for distortion in sensitive analog signals, FlexRes oscilloscopes are the answer.

FlexRes is available on the 8-channel PicoScope 6824E and the 4-channel PicoScope 6424E.

Resolution enhancement—a digital signal processing technique built into PicoScope 6—can further increase the effective vertical resolution of the scope to 16 bits.

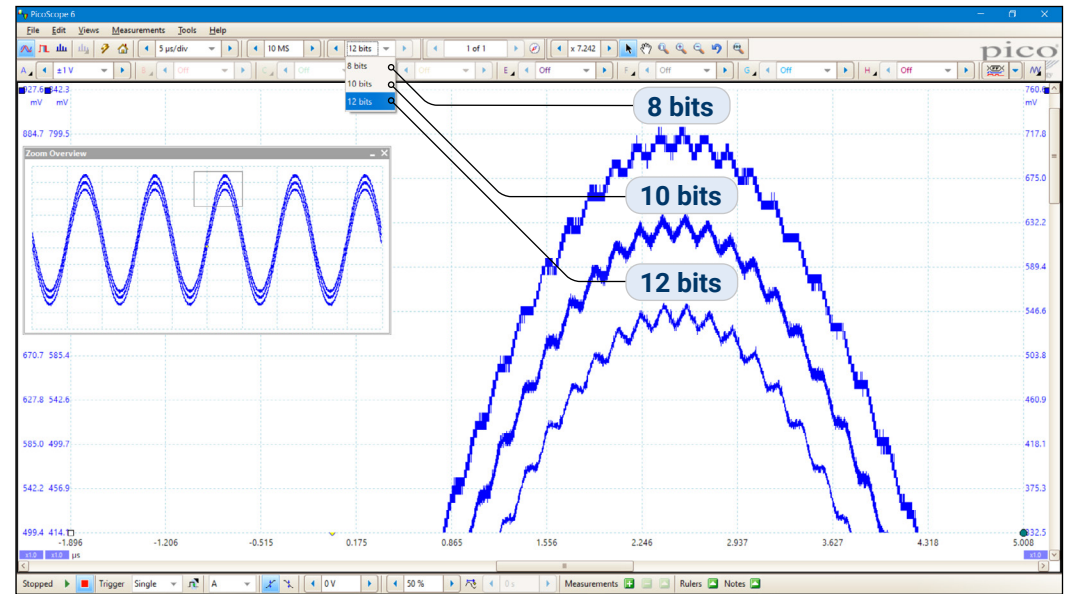

FlexRes – how we do it

Most digital oscilloscopes gain their high sampling rates by interleaving multiple 8-bit ADCs. This interleaving process introduces errors that always make the dynamic performance worse than that of the individual ADC cores.

The FlexRes architecture employs multiple high-resolution ADCs at the input channels in different time-interleaved and parallel combinations to optimize, for example, the sampling rate to 5 GS/s at 8 bits or the resolution to 12 bits at 1.25 GS/s.

For simplicity, the diagram shows one bank of four channels; the 8-channel PicoScope 6824E has two banks. The PicoScope 6424E uses one quad-ADC chip for each pair of analog channels.

Coupled with high signal-to-noise ratio amplifiers and a low-noise system architecture, FlexRes technology can capture and display signals up to 500 MHz with a high sampling rate, or lower-speed signals with 16 times more resolution than typical 8-bit oscilloscopes.

PicoScope 6 software lets you choose between setting the resolution manually and leaving the scope in **auto resolution** mode, where the optimal resolution is used for the chosen settings.

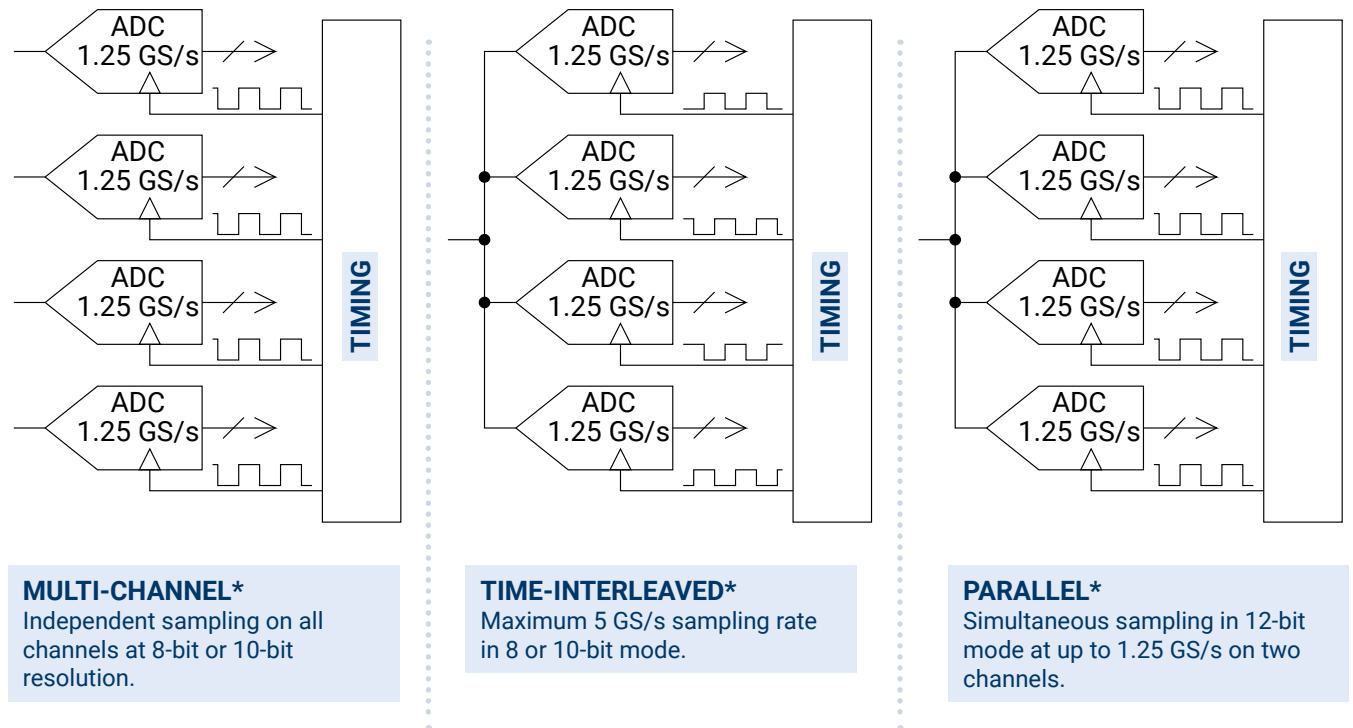

* See technical specifications for channel and sampling rate combinations.

Mixed signal option

When fitted with optional 8-channel TA369 MSO pods, the PicoScope 6000E Series adds up to 16 high-performance digital channels to up to eight analog channels, enabling you to accurately time-correlate analog and digital channels. Digital channel bandwidth is 500 MHz, equivalent to 1 Gb/s, and the input capacitance of only 3.5 pF minimizes loading on the device under test.

Digital channels, captured from either parallel or multiple serial buses, may be grouped and displayed as a bus, with each bus value displayed in hex, binary or decimal, or as a level (for DAC testing). You can set advanced triggers across the analog and digital channels.

The digital inputs also bring extra power to the serial decoding feature. You can decode serial data on all analog and digital channels simultaneously, giving you up to 24 channels of data – for example, decoding multiple SPI, I²C, CAN bus, LIN bus and FlexRay signals all at the same time!

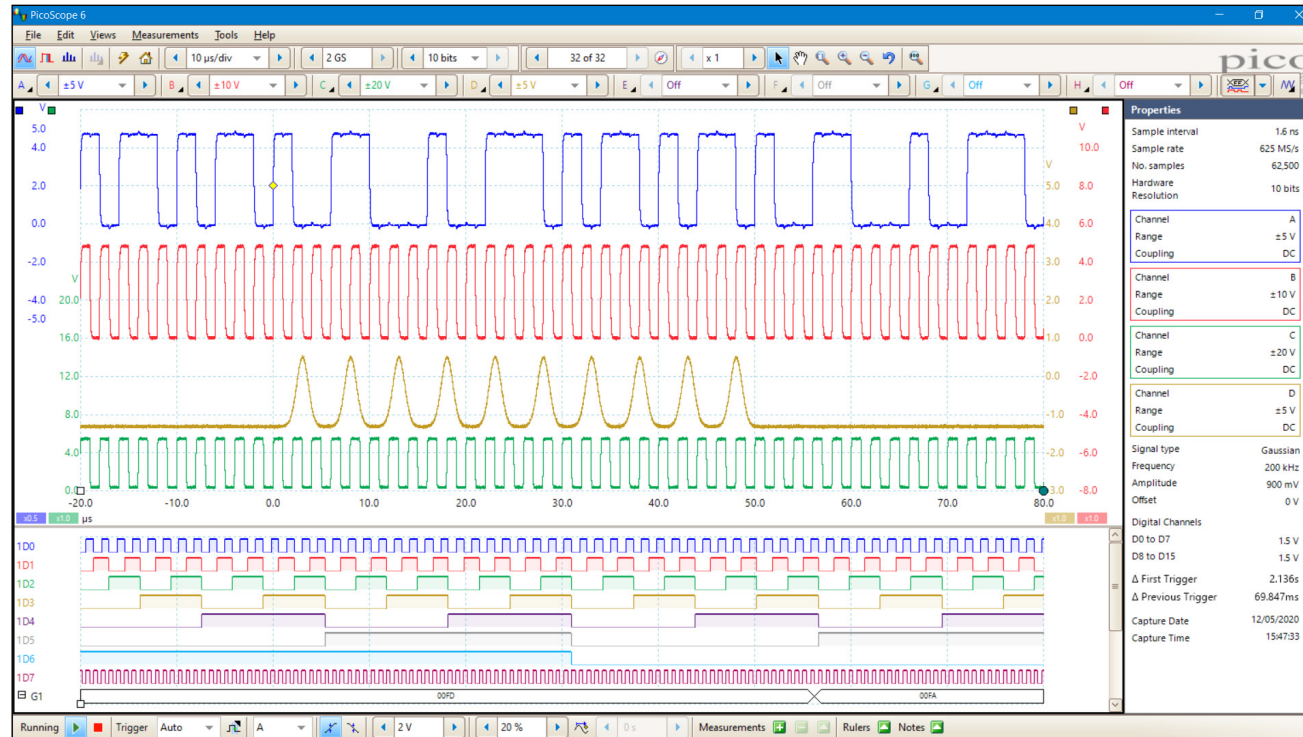

Analog waveforms (top) and digital waveforms (bottom) shown on PicoScope 6 display



TA369 MSO pod with 8 digital inputs

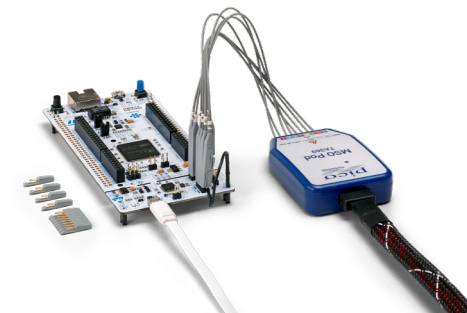

Digital channels connected to a device under test

PicoScope 6000E Series inputs, outputs and indicators

8-channel front panel

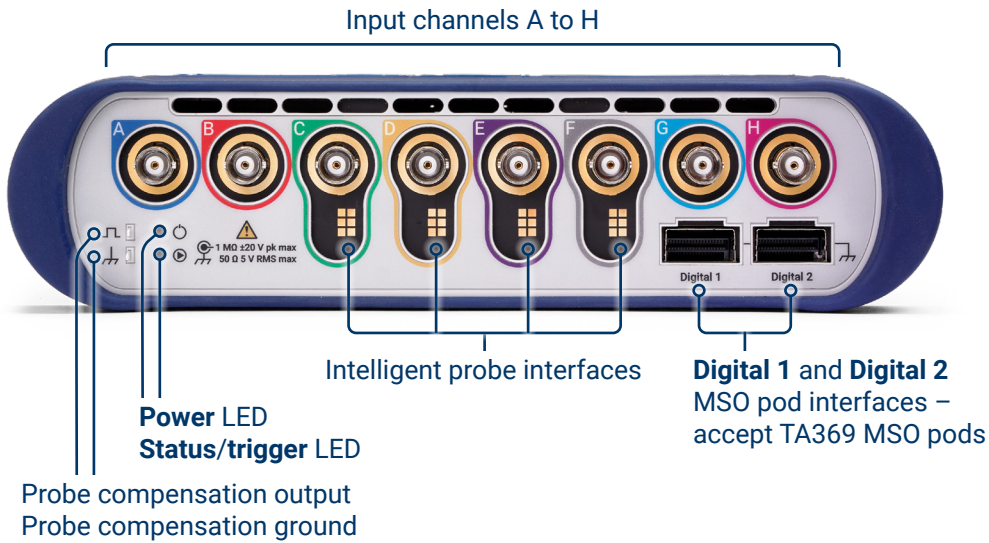

Rear-panel

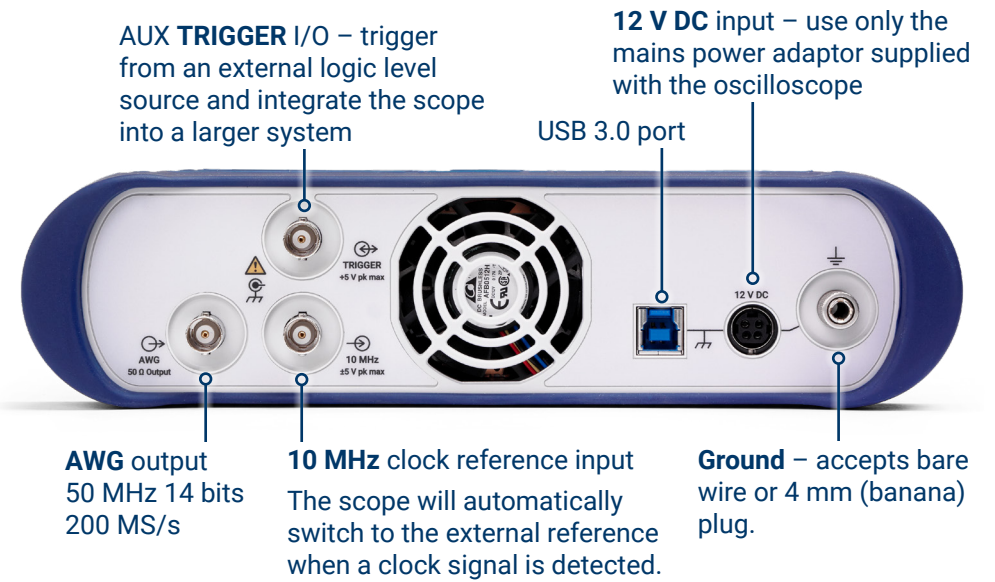

4-channel front-panel

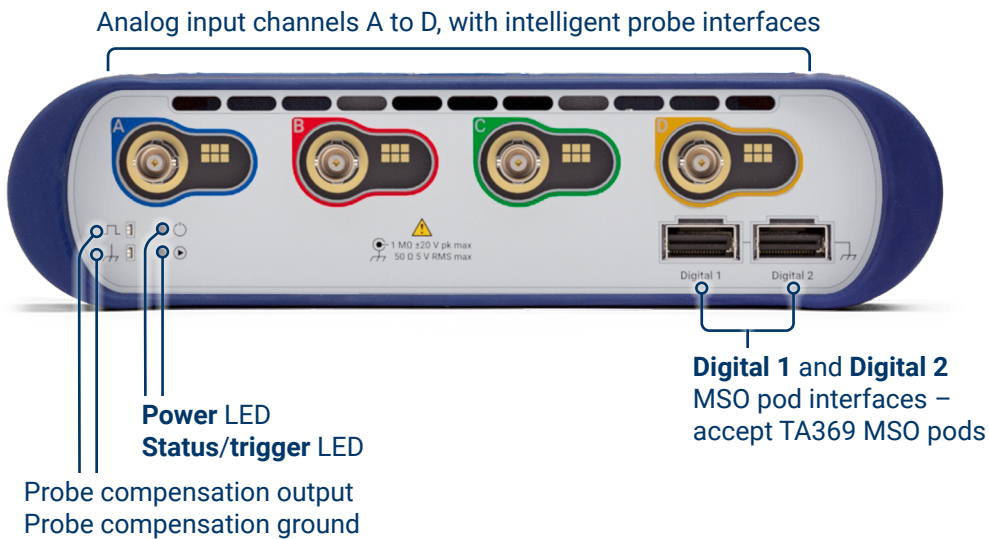

Intelligent probe interface (probes coming soon!)

With an intelligent probe interface on channels C to F on 8-channel models and all channels on 4-channel models, the PicoScope 6000E Series will support innovative active probes with a low-profile mechanical design for ease of connectivity and low loading of the device under test.

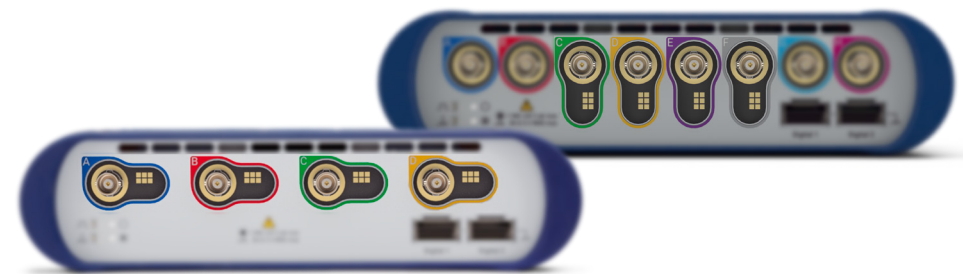

PicoScope 6 software

The display can be as simple or as advanced as you need. Begin with a single view of one channel, and then expand the display to include any number of live channels, math channels and reference waveforms.

Tools: Including serial decoding, reference channels, macro recorder, alarms, mask limit testing and math channels.

Waveform replay tools: PicoScope 6 automatically records up to 10 000 of the most recent waveforms. You can quickly scan through to look for intermittent events, or use the **Buffer Navigator** to search visually.

Zoom and pan tools: PicoScope 6 allows a zoom factor of several million, which is necessary when working with the ultra-deep memory of the 6000E Series scopes.

Signal generator: Generates standard signals or arbitrary waveforms. Includes frequency sweep mode.

Ruler legend: Absolute and differential ruler measurements are listed here.

Auto setup button: Configures the collection time and voltage range for clear display of signals.

Channel options: Filtering, offset, resolution enhancement, custom probes and more.

Oscilloscope controls: Controls such as voltage range, scope resolution, channel enable, timebase and memory depth.

Movable axes: The vertical axes can be scaled and dragged up or down. This feature is particularly useful when one waveform is obscuring another. There's also an **Auto Arrange Axes** command.

Zoom overview: Click and drag for quick navigation in zoomed views.

Trigger toolbar: Quick access to main controls, with advanced triggers in a pop-up window.

Automatic measurements: Display calculated measurements for troubleshooting and analysis. You can add as many measurements as you need on each view. Each measurement includes statistical parameters showing its variability.

Trigger marker: Drag the yellow diamond to adjust trigger level and pre-trigger time.

Rulers: Each axis has two rulers that can be dragged across the screen to make quick measurements of amplitude, time and frequency.

Properties sheet: Shows a summary of the settings that PicoScope is using.

Views: PicoScope 6 is carefully designed to make the best use of the display area. You can add new scope, spectrum and XY views with automatic or custom layouts.



Advanced display

PicoScope 6 software dedicates the majority of the display area to the waveform, ensuring that the maximum amount of data is visible at all times. The size of the display is only limited by the size of your computer's monitor, so even with a laptop, the viewing area is much bigger, with much higher resolution, than that of a benchtop scope.

With such a large display area available, you can create a customizable split-screen display and view multiple channels or different views of the same signal at the same time – the software can even show multiple oscilloscope and spectrum analyzer views at once. Each view has separate zoom, pan and filter settings, for ultimate flexibility.

You can control the PicoScope software using a mouse, a touchscreen or customizable keyboard shortcuts.

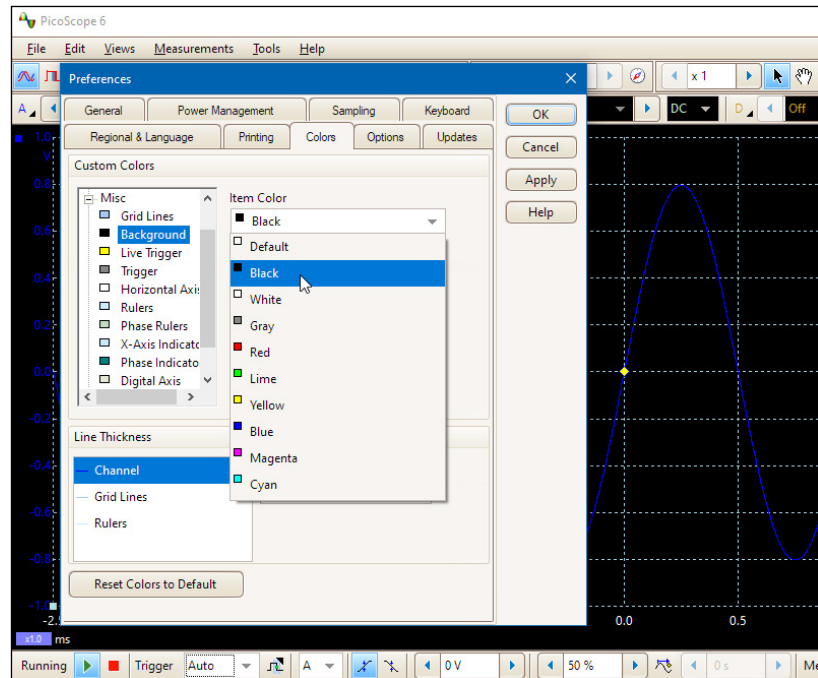
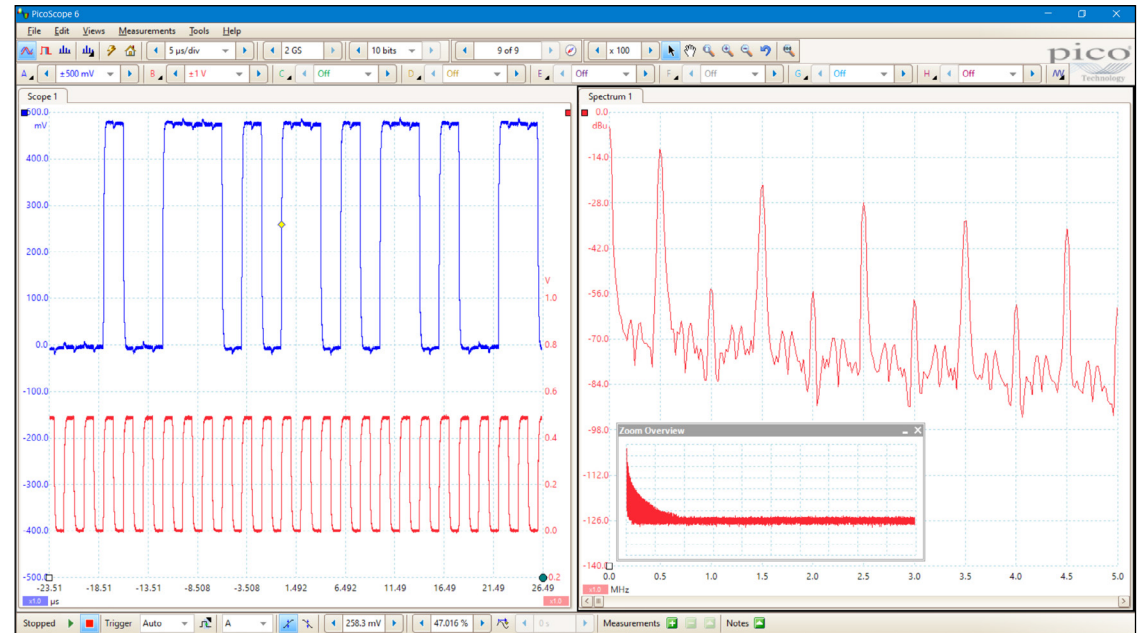

PicoScope 6 custom colors

In PicoScope 6, you can customize the color scheme and line thicknesses. Display elements you can adjust in this way include the channel traces, background color and grid lines.



SuperSpeed USB 3.0 connection

PicoScope 6000E Series oscilloscopes feature a USB 3.0 connection, providing lightning-fast saving of waveforms while retaining compatibility with older USB standards.

PicoSDK® supports continuous streaming to the host computer at rates of over 300 MS/s.

The USB connection not only allows high-speed data acquisition and transfer, but also makes printing, copying, saving and emailing your data from the field quick and easy.

Signal fidelity

Careful front-end design and shielding reduces noise, crosstalk and harmonic distortion. PicoScope 6000E Series oscilloscopes exhibit a dynamic performance of up to 60 dB SFDR.

With PicoScope 6, when you probe a circuit, you can trust in the waveform you see on the screen.

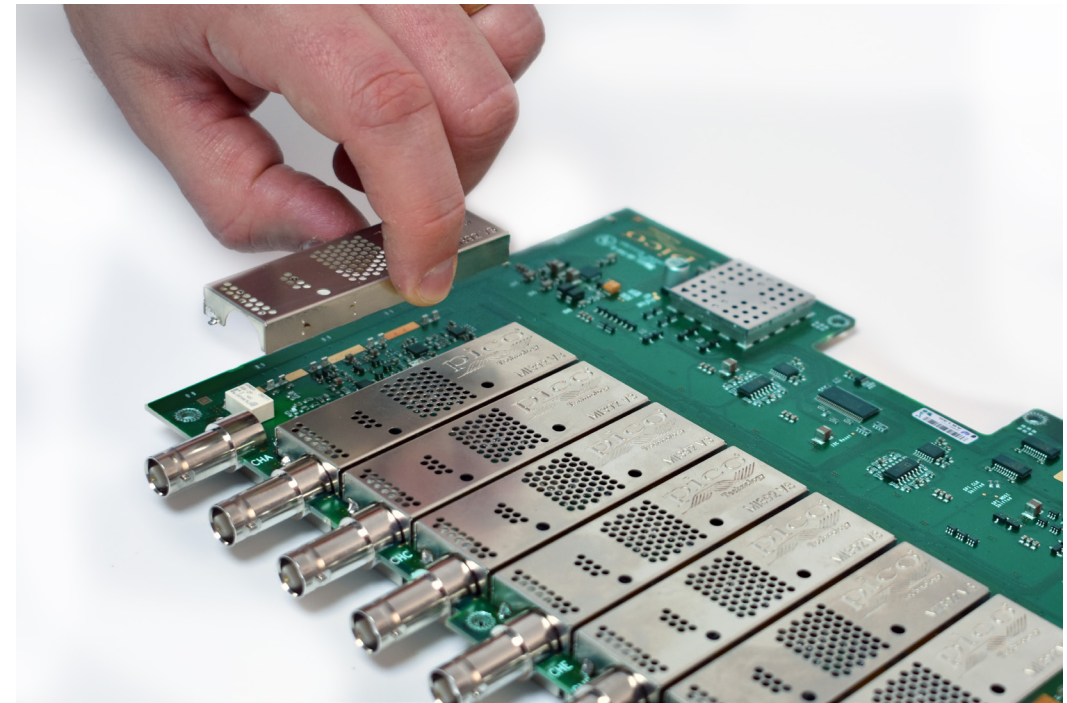
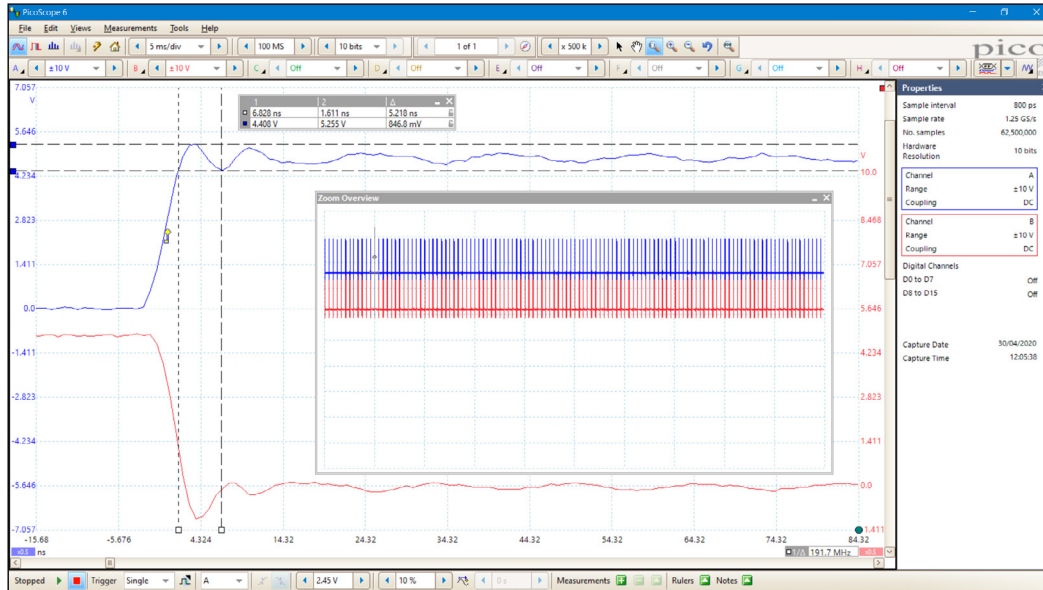

High resolution for low-level signals

With their 12-bit resolution, the PicoScope 6824E and 6424E can display low-level signals at high zoom factors. This allows you to view and measure features such as noise and ripple superimposed on larger DC or low-frequency voltages.

Additionally, you can use the **lowpass filtering** controls on each channel independently, to hide noise and reveal the underlying signal.

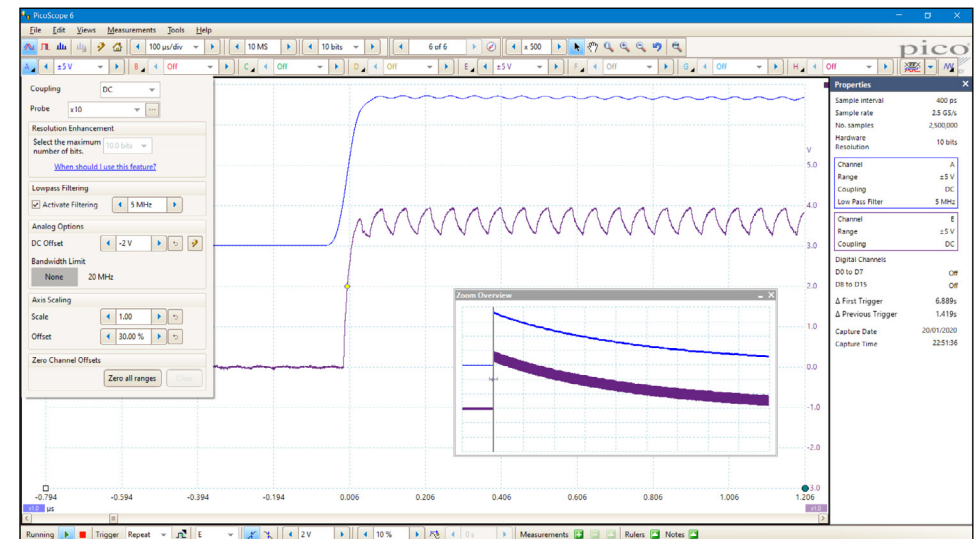

High-end features as standard

Buying a PicoScope is not like making a purchase from other oscilloscope companies, where optional extras considerably increase the price. With our scopes, high-end features such as serial decoding, mask limit testing, advanced math channels, segmented memory, hardware-based time-stamping and a signal generator are all included in the price.

To protect your investment, both the PC software and firmware inside the scope can be updated. Pico Technology has a long history of providing new features for free through software downloads. We deliver on our promises of future enhancements year after year. Users of our products reward us by becoming lifelong customers and frequently recommending us to their colleagues.

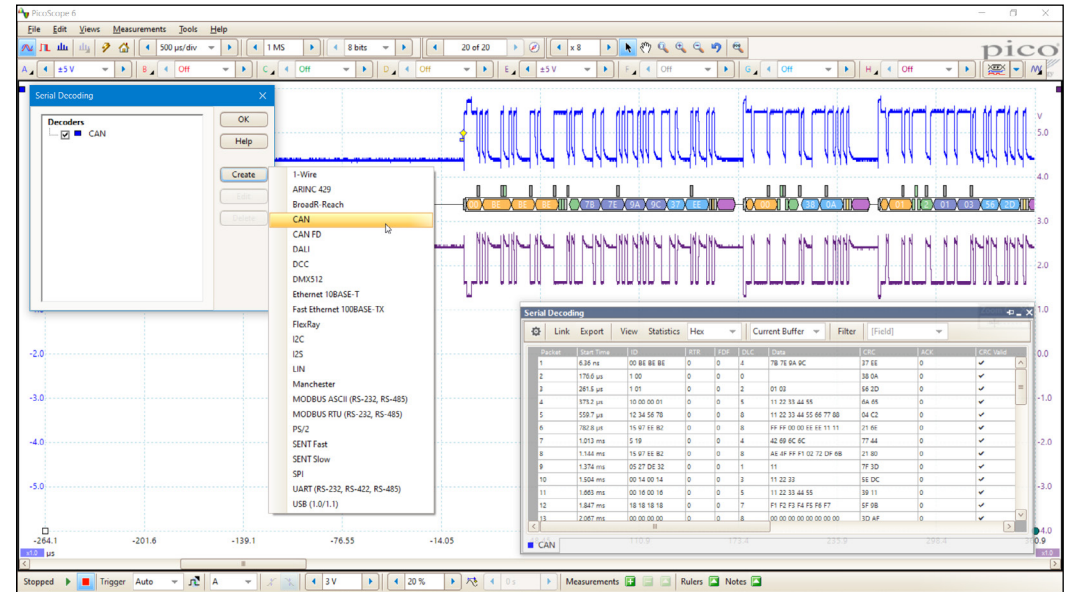

Total cost of ownership (TCO) and environmental benefits

Total cost of ownership of a PicoScope 6000E is lower than traditional benchtop instruments for several reasons:

1. Low power consumption - just 60W - saves hundreds of dollars throughout the lifetime of the product compared to benchtop instruments. It's kinder to the environment too, with lower CO2 emissions.
2. Everything is included in the purchase price: serial protocol decoders / math channels and mask limit testing. No expensive optional upgrades or annual license fees.
3. Free updates: new features and capabilities are provided throughout the lifetime of the product as we develop and release them.



Ultra-deep memory

PicoScope 6000E Series oscilloscopes have waveform capture memories of up to 4 gigasamples – many times larger than competing scopes. Deep memory enables the capture of long-duration waveforms at maximum sampling speed. In fact, the PicoScope 6000E Series can capture waveforms 200 ms long with 200 ps resolution. In contrast, the same 200 ms waveform captured by an oscilloscope with a 10 megasample memory would have just 20 ns resolution. The scope automatically shares the capture memory between the analog channels and MSO ports you have enabled.

Deep memory is invaluable when you need to capture fast serial data with long gaps between packets, or nanosecond laser pulses spaced milliseconds apart, for example. It can be useful in other ways too: PicoScope lets you divide the capture memory into a number of segments, up to 10 000. You can set up a trigger condition to store a separate capture in each segment, with as little as 300 ns dead time between captures. Once you have acquired the data, you can step through the memory one segment at a time until you find the event you are looking for.

Powerful tools are included to allow you to manage and examine all of this data. As well as functions such as mask limit testing and color persistence mode, PicoScope 6 software enables you to zoom into your waveform up to 100 million times. The Zoom Overview window allows you to easily control the size and location of the zoom area. Other tools, such as the waveform buffer, serial decoding and hardware acceleration work with the deep memory, making the PicoScope 6000E Series some of the most powerful oscilloscopes on the market.

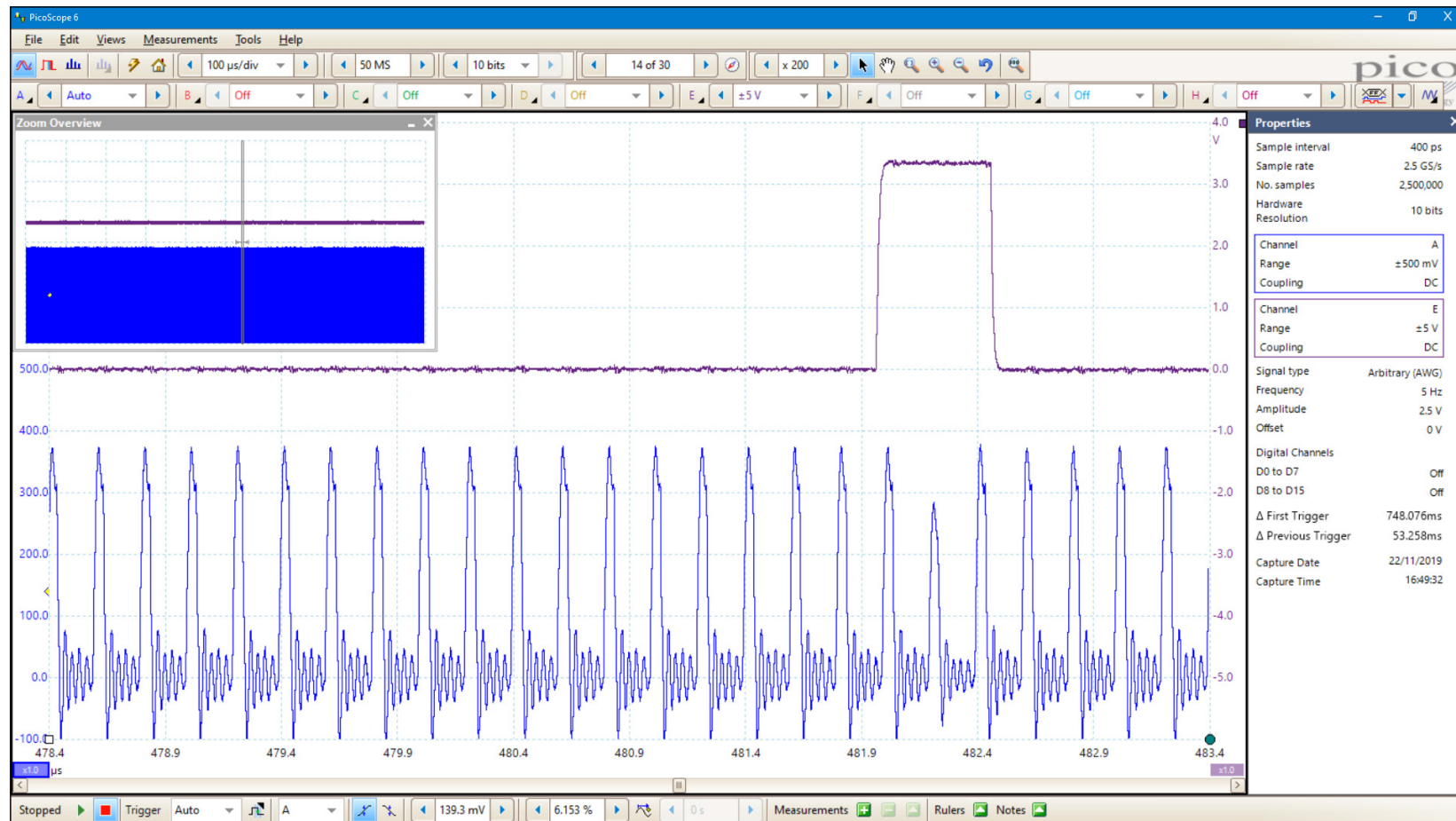

Persistence mode

PicoScope's persistence mode options allow you to see old and new data superimposed, making it easy to spot glitches and dropouts and estimate their relative frequency – useful for displaying and interpreting complex analog signals such as video waveforms and amplitude modulated signals. Color-coding and intensity-grading show which areas are stable and which are intermittent. Choose between **Digital Color**, **Analog Intensity**, **Fast** and **Advanced** display modes or create your own custom setup.

An important specification to understand when evaluating oscilloscope performance, especially in persistence mode, is the waveform update rate, which is expressed as waveforms per second. While the sampling rate indicates how frequently the oscilloscope samples the input signal within one waveform or cycle, the waveform capture rate refers to how quickly an oscilloscope acquires waveforms.

Oscilloscopes with high waveform capture rates provide better visual insight into signal behavior and dramatically increase the probability that the oscilloscope will quickly capture transient anomalies such as jitter, runt pulses and glitches – that you may not even know exist.

The PicoScope 6000E Series' HAL4 hardware acceleration can achieve update rates of 300 000 waveforms per second in fast persistence mode.

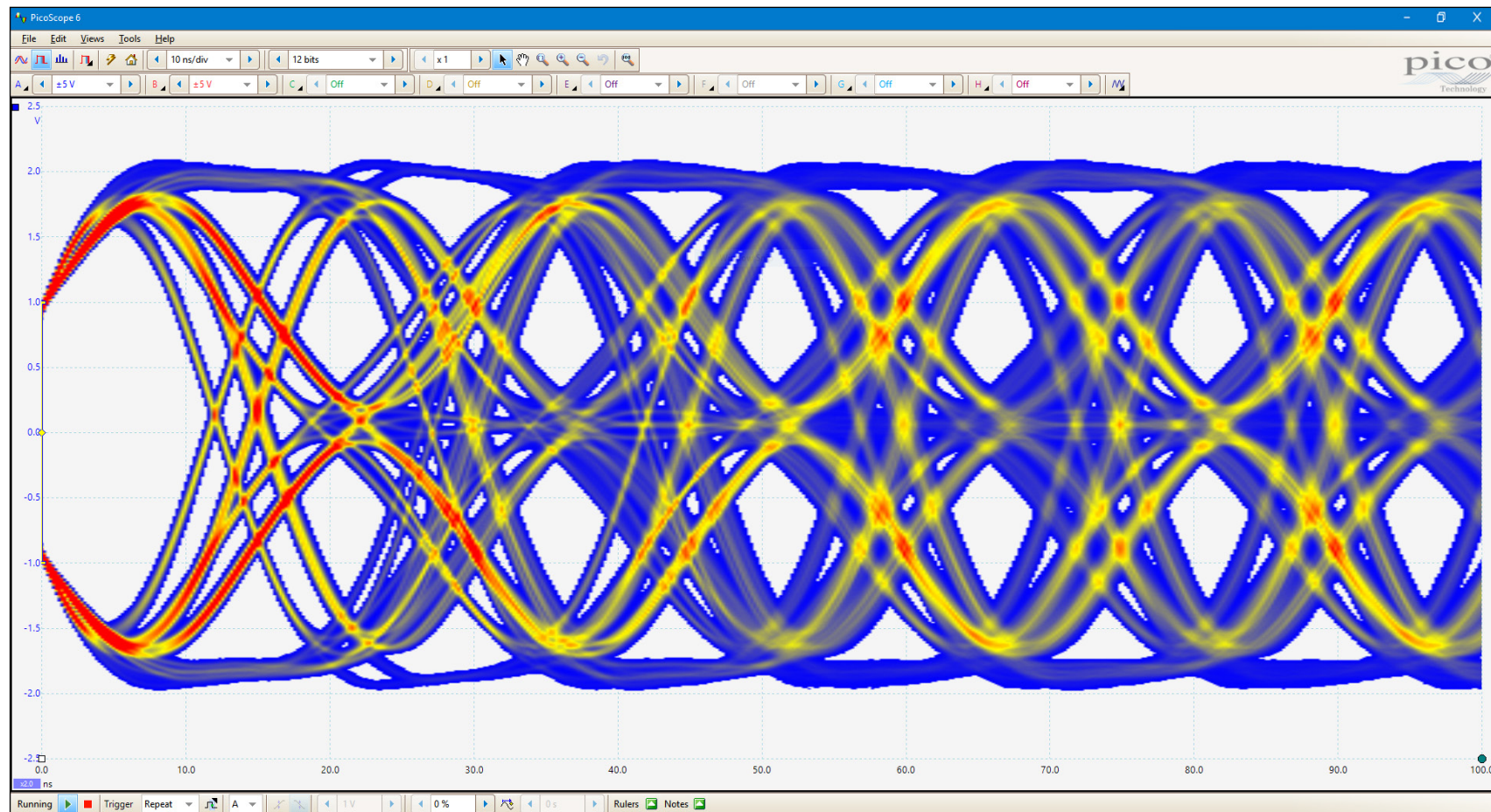

Serial bus decoding and protocol analysis

PicoScope can decode 1-Wire, ARINC 429, BroadR-Reach, CAN & CAN FD, DALI, DCC, DMX512, Ethernet 10Base-T and 100Base-TX, FlexRay, I²C, I²S, LIN, PS/2, Manchester, Modbus, SENT, SPI, UART (RS-232 / RS-422 / RS-485), and USB 1.1 protocol data as standard, with more protocols in development and available in the future with free-of-charge software upgrades.

Graph format shows the decoded data (in hex, binary, decimal or ASCII) in a data-bus timing format beneath the waveform on a common time axis, with error frames marked in red. These frames can be zoomed to investigate noise or signal integrity issues.

Table format shows a list of the decoded frames, including the data and all flags and identifiers. You can set up filtering conditions to display only the frames you are interested in or search for frames with specified properties. The statistics option reveals more detail about the physical layer such as frame times and voltage levels. PicoScope can also import a spreadsheet to decode the data into user-defined text strings.

Click on a frame in the table to zoom the oscilloscope display and show the waveform for that frame.

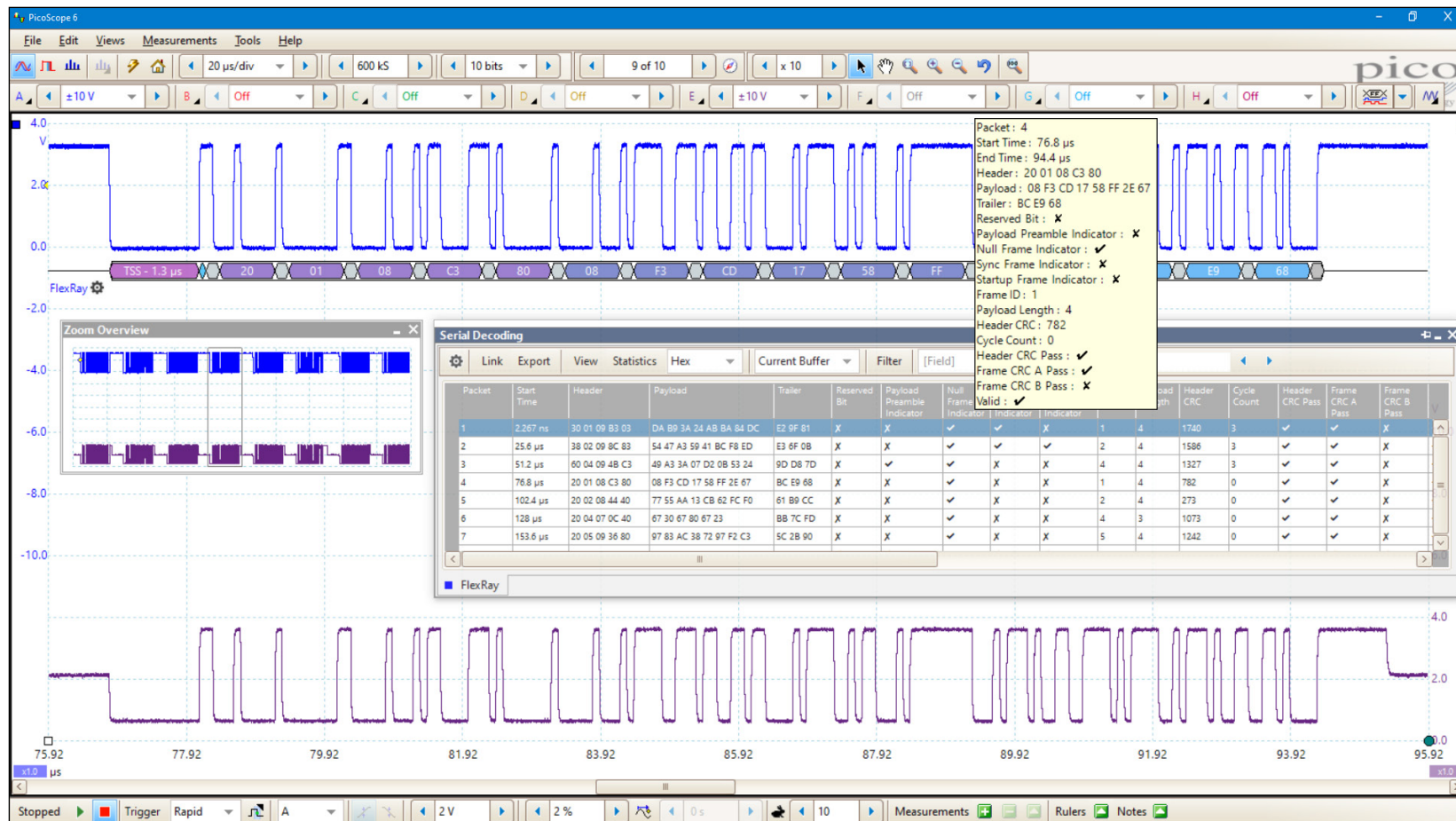

DeepMeasure

One waveform, millions of measurements.

Measurement of waveform pulses and cycles is key to verification of the performance of electrical and electronic devices.

DeepMeasure delivers automatic measurements of important waveform parameters, such as pulse width, rise time and voltage. Up to a million cycles can be displayed with each triggered acquisition. Results can be easily sorted, analyzed and correlated with the waveform display.

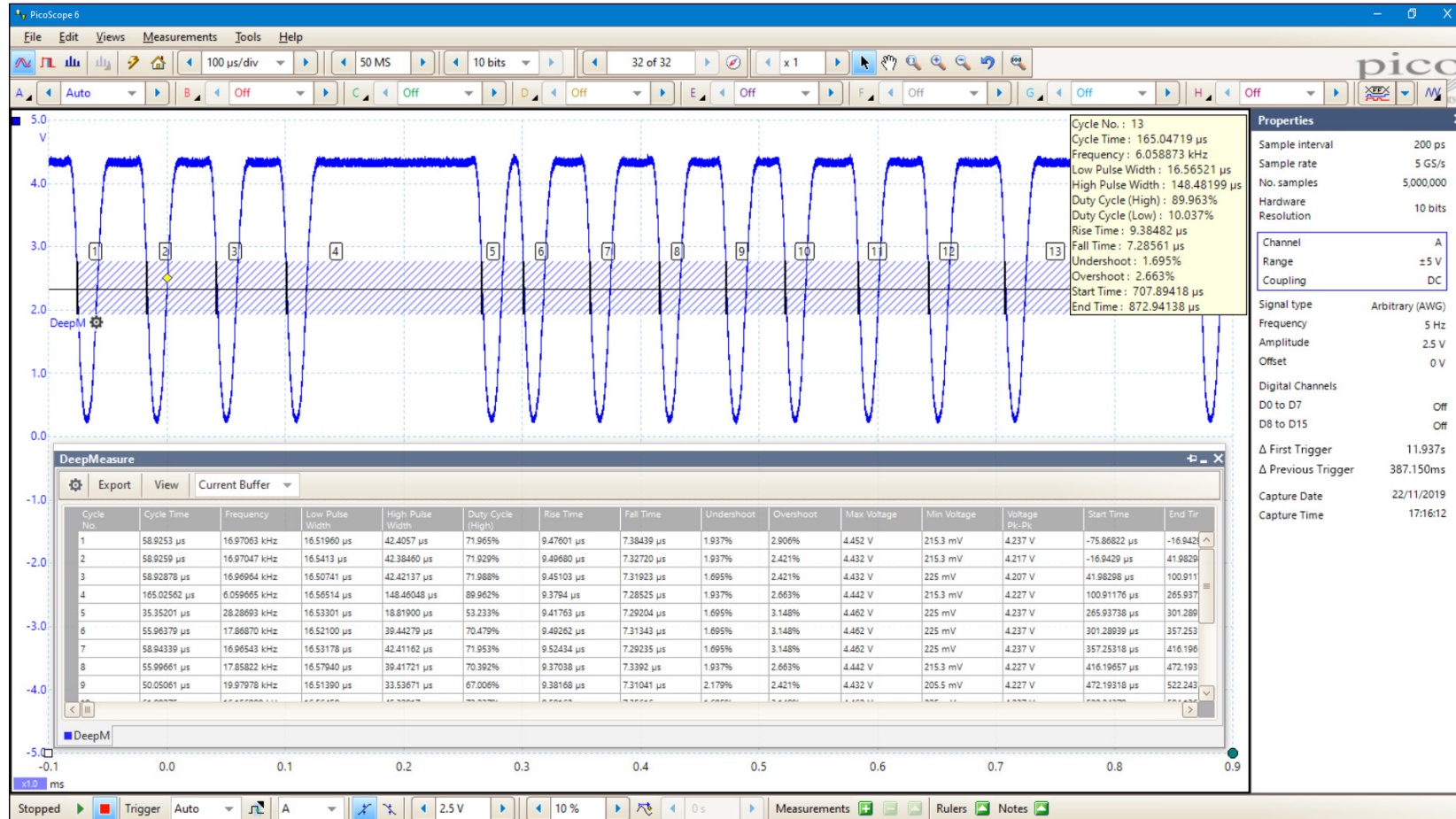

Mask limit testing

Mask limit testing allows you to compare live signals against known good signals, and is designed for production and debugging environments. Simply capture a known good signal, draw (or have PicoScope auto-generate) a mask and then measure the system under test. PicoScope will check for mask violations and perform pass/fail testing, capture intermittent glitches, and can show a failure count and other statistics in the Measurements window.

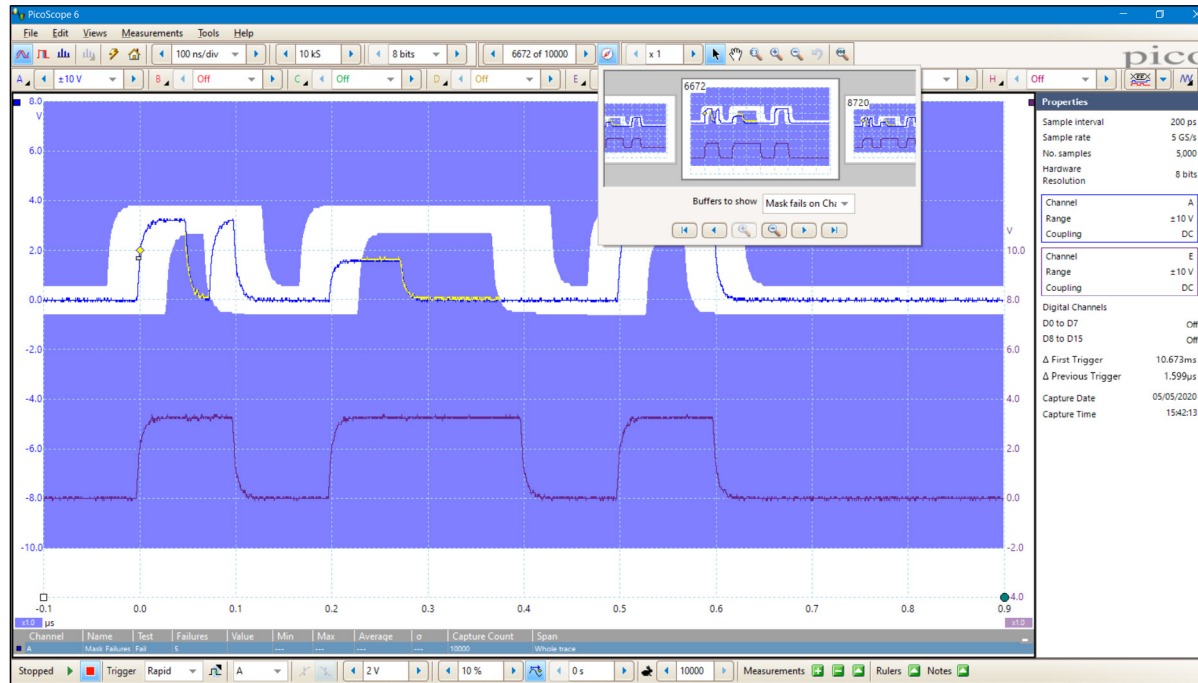

Waveform buffer and navigator

Ever spotted a glitch on a waveform, but by the time you've stopped the scope it has gone? With PicoScope you don't need to worry about missing glitches or other transient events. PicoScope can store the last ten thousand oscilloscope or spectrum waveforms in its circular waveform buffer.

The buffer navigator provides an efficient way of navigating and searching through waveforms, effectively letting you turn back time. Tools such as mask limit testing can also be used to scan through each waveform in the buffer looking for mask violations.

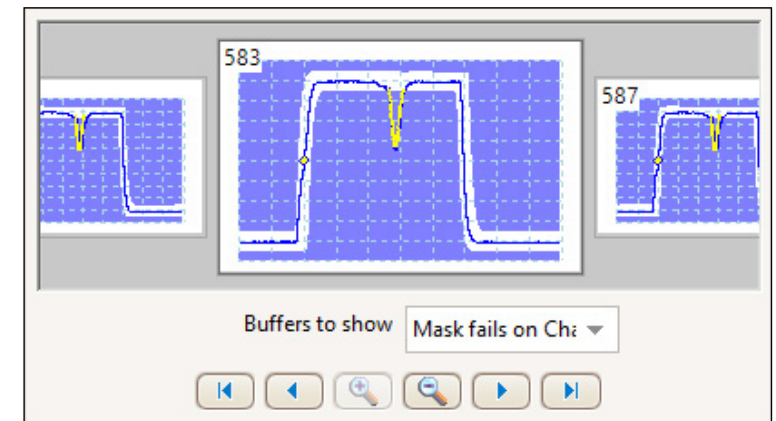
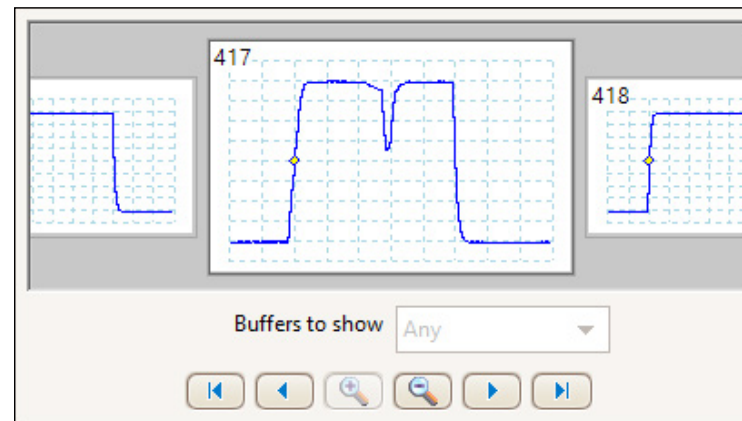

FFT spectrum analyzer

The spectrum view plots amplitude against frequency and is ideal for finding noise, crosstalk or distortion in signals. The spectrum analyzer in PicoScope is of the Fast Fourier Transform (FFT) type that, unlike a traditional swept spectrum analyzer, can display the spectrum of a single, non-repeating waveform. With up to a million points, PicoScope's FFT has excellent frequency resolution and a low noise floor.

With a click of a button, you can display a spectrum plot of the active channels, with a maximum frequency of up to 500 MHz. A full range of settings gives you control over the number of spectrum bands (FFT bins), scaling (including log/log) and display modes (instantaneous, average, or peak-hold). A selection of window functions allow you to optimize for selectivity, accuracy or dynamic range.

You can display multiple spectrum views alongside oscilloscope views of the same data. A comprehensive set of automatic frequency-domain measurements can be added to the display, including THD, THD+N, SNR, SINAD and IMD. A mask limit test can be applied to a spectrum and you can even use the AWG and spectrum mode together to perform swept scalar network analysis.

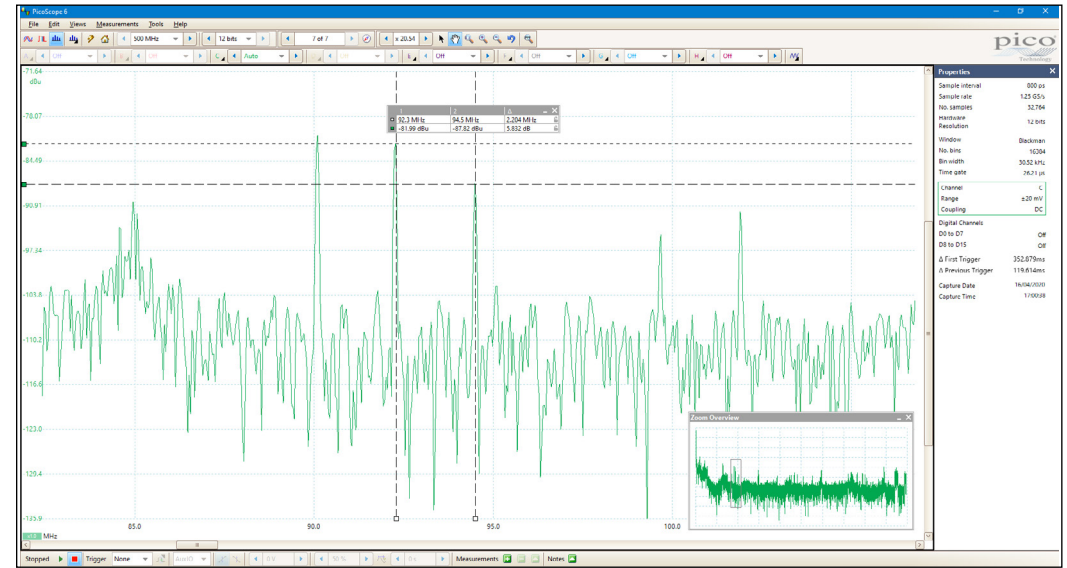

FM radio broadcasts

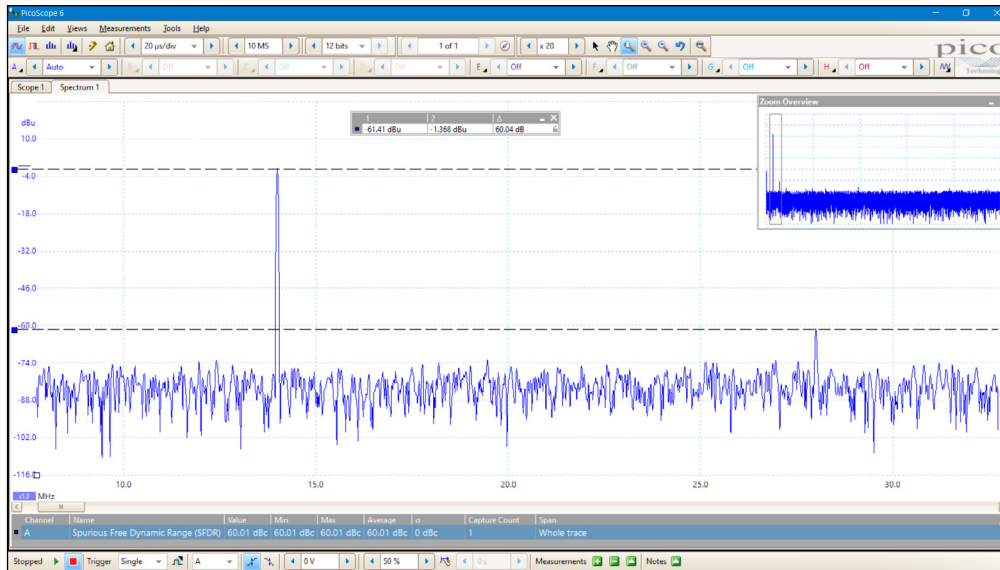

10 MHz sine wave showing 60 dB SFDR

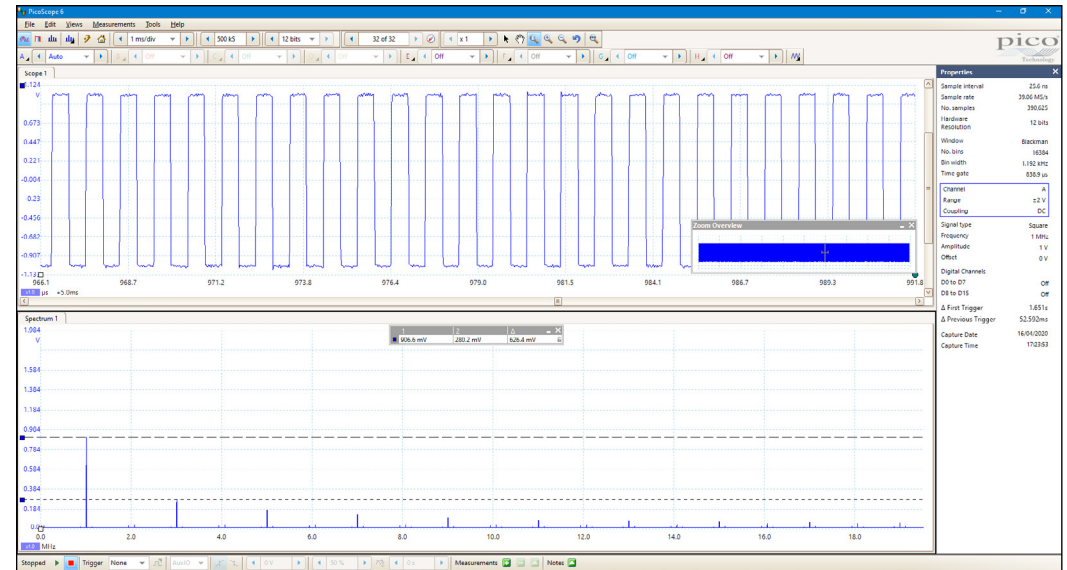

Harmonics of a square-wave signal

Powerful tools provide endless options

Your PicoScope is provided with many powerful tools to help you acquire and analyze waveforms. While these tools can be used on their own, the real power of PicoScope lies in the way they have been designed to work together.

As an example, the rapid trigger mode allows you to collect 10 000 waveforms in a few milliseconds with minimal dead time between them. Manually searching through these waveforms would be time-consuming, so just pick a waveform you are happy with and let the mask tools scan through for you. When done, the measurements will tell you how many have failed and the buffer navigator allows you to hide the good waveforms and just display the problem ones.

The screenshot below shows changing frequency versus time as a graph. Perhaps instead you want to plot changing duty cycle as a graph? How about outputting a waveform from the AWG and also automatically saving the waveform to disk when a trigger condition is met? With the power of PicoScope the possibilities are almost endless. To find out even more about the capabilities of PicoScope software, visit our online [A to Z of PC Oscilloscopes](#).

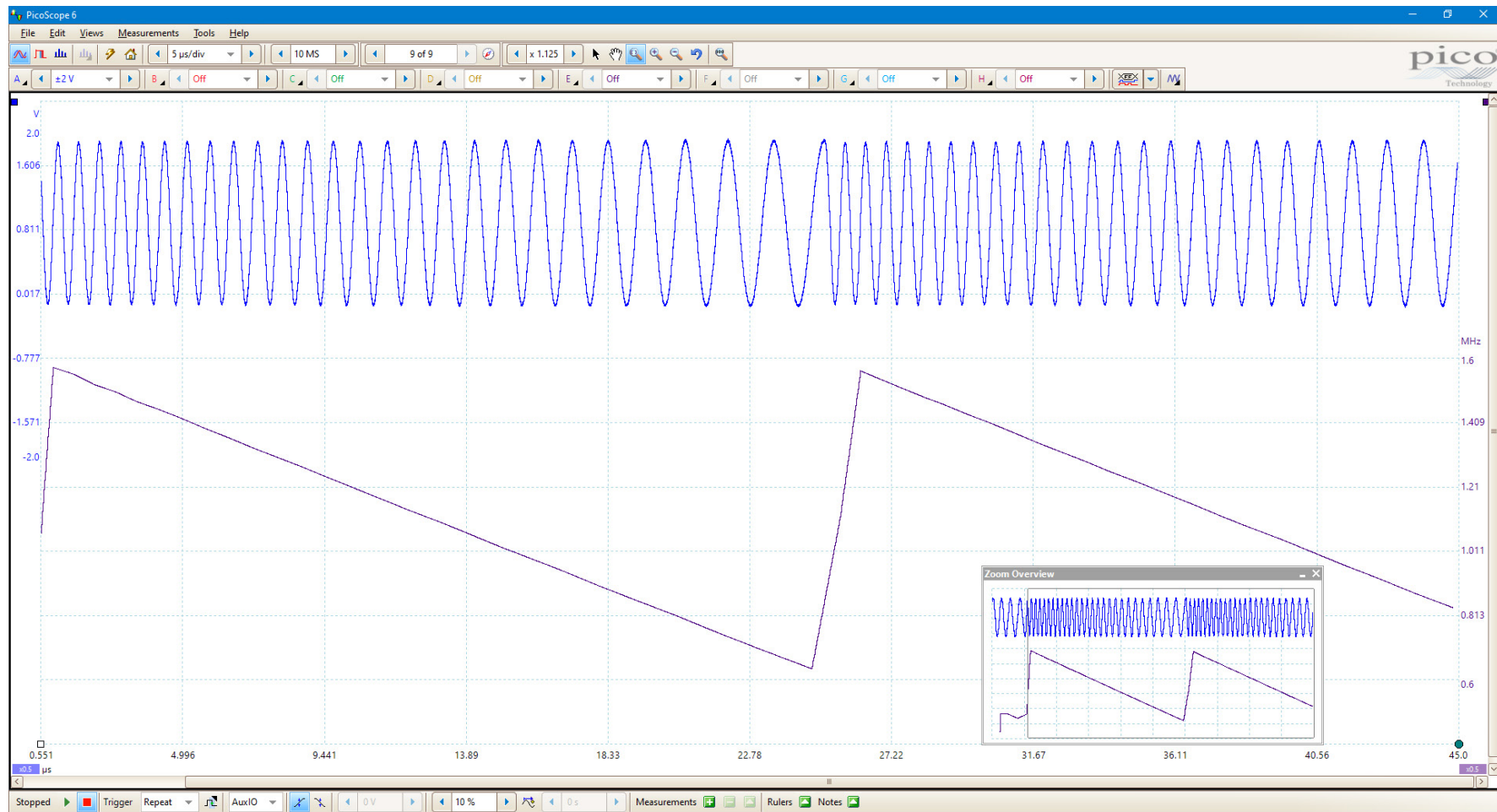

Arbitrary waveform and function generator

The PicoScope 6000E scopes have a built-in 50 MHz function (sine and square wave) generator, with triangle, DC level, white noise, PRBS and other waveforms possible at lower frequencies. As well as basic controls to set level, offset and frequency, more advanced controls allow you to sweep over a range of frequencies. Combined with the spectrum peak-hold option, this makes a powerful tool for testing amplifier and filter responses.

Trigger tools allow one or more cycles of a waveform to be output when various conditions are met, such as the scope triggering or a mask limit test failing.

All models include a 14-bit 200 MS/s arbitrary waveform generator (AWG). This has a variable sample clock, which avoids the jitter on waveform edges seen with fixed-clock generators and allows generation of accurate frequencies down to 100 μ Hz. AWG waveforms can be created or edited using the built-in editor, imported from oscilloscope traces, loaded from a spreadsheet or exported to a .csv file.

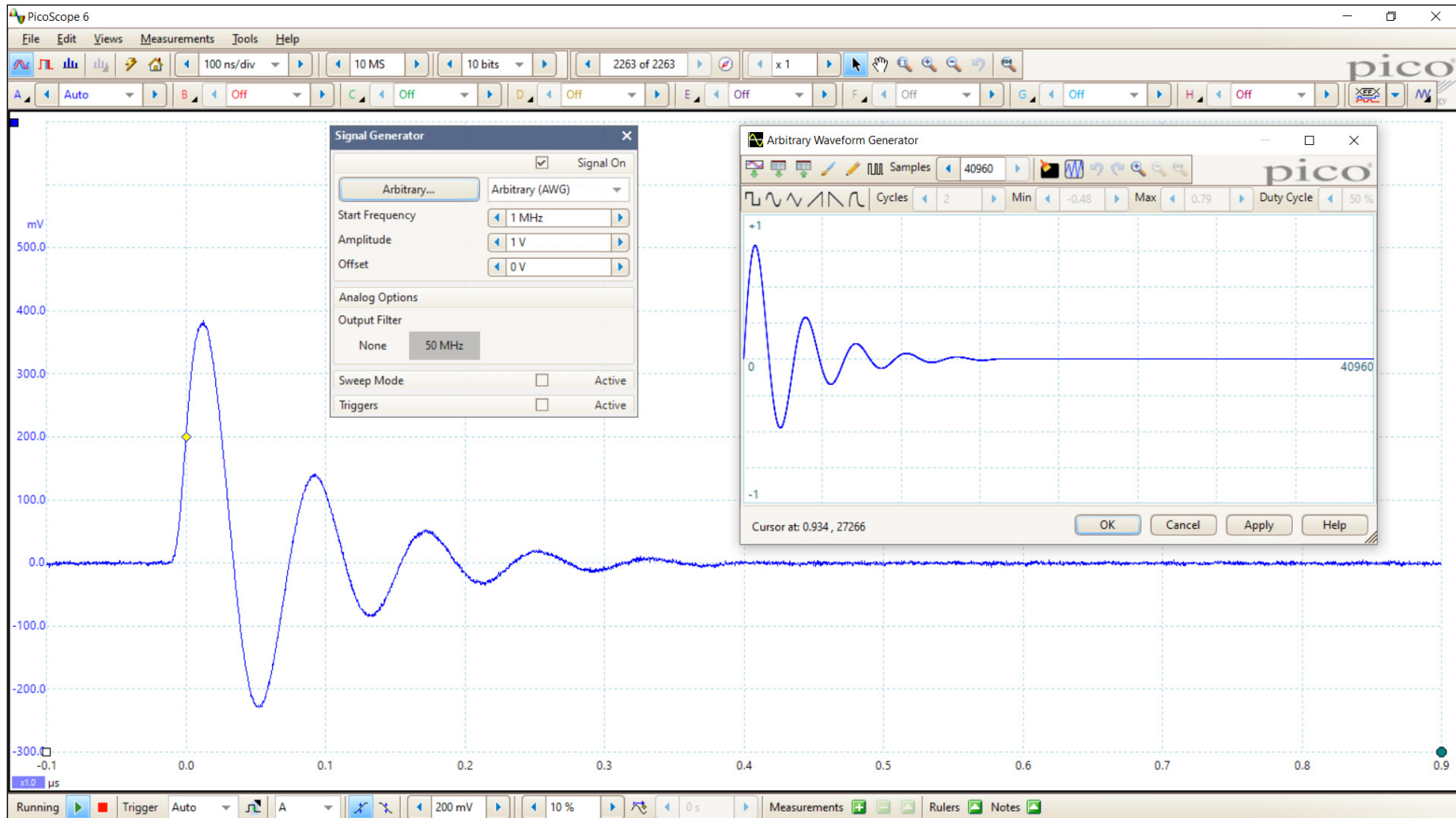

Digital triggering architecture

Many digital oscilloscopes still use an analog trigger architecture based on comparators. This causes time and amplitude errors that cannot always be calibrated out and often limits the trigger sensitivity at high bandwidths.

In 1991 Pico pioneered the use of fully digital triggering using the actual digitized data. This technique reduces trigger errors and allows our oscilloscopes to trigger on the smallest signals, even at the full bandwidth. Trigger levels and hysteresis can be set with high precision and resolution.

Advanced triggers

The PicoScope 6000E Series offers an industry-leading set of advanced trigger types including pulse width, runt pulse, windowed, logic and dropout.

The digital trigger available during MSO operation allows you to trigger the scope when any or all of the 16 digital inputs match a user-defined pattern. You can specify a condition for each channel individually, or set up a pattern for all channels at once using a hexadecimal or binary value.

You can also use the logic trigger to combine the digital trigger with an edge or window trigger on any of the analog inputs, for example to trigger on data values in a clocked parallel bus.

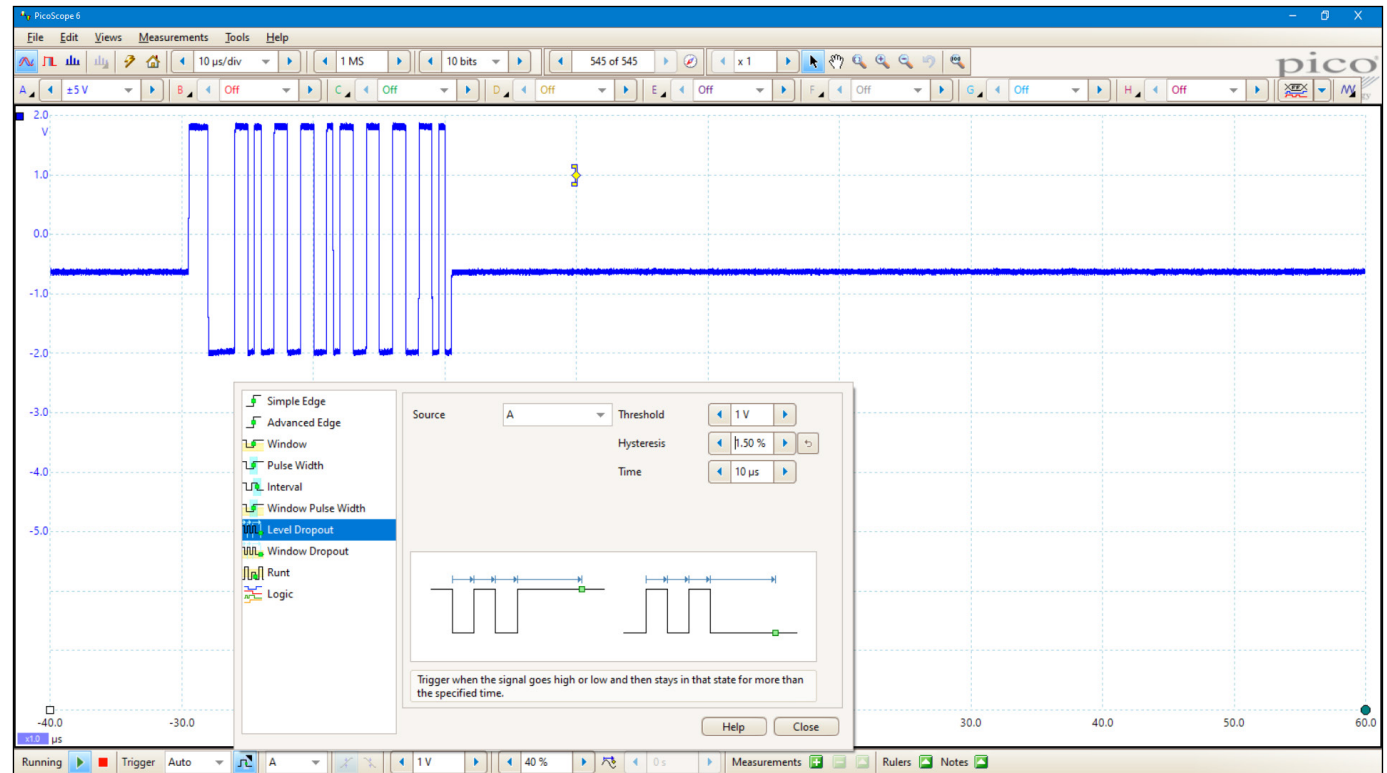

Alarms

PicoScope can be programmed to execute actions when certain events occur.

The events that can trigger an alarm include mask limit fails, trigger events and buffers full.

The actions that PicoScope can execute include saving a file, playing a sound, executing a program and triggering the signal generator or the AWG.

Alarms, coupled with mask limit testing, help create a powerful and time-saving waveform monitoring tool. Capture a known good signal, auto-generate a mask around it and then use the alarms to automatically save any waveform (complete with a time/date stamp) that does not meet specification.

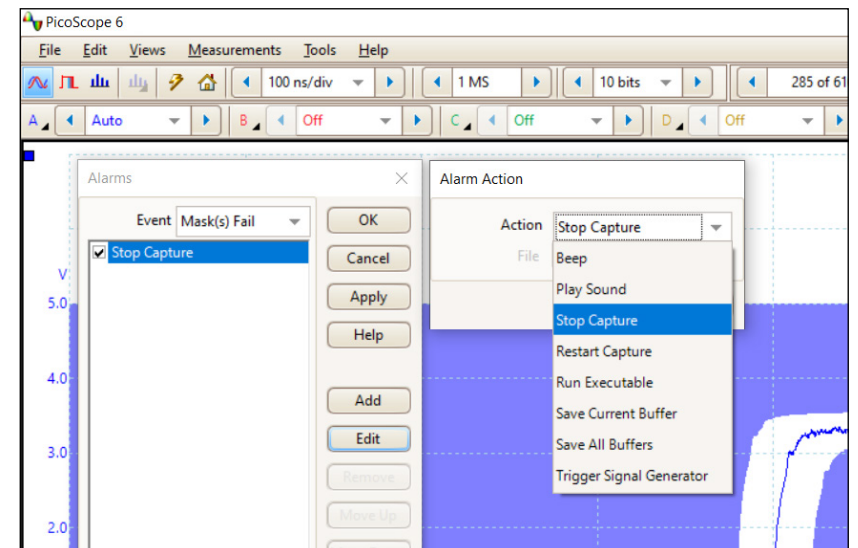

Hardware acceleration engine (HAL4)

Some oscilloscopes struggle when you enable deep memory; the screen update rate slows and the controls become unresponsive. The PicoScope 6000E Series avoids this limitation with the use of a dedicated fourth-generation hardware acceleration (HAL4) engine inside the oscilloscope.

Its massively parallel design effectively creates the waveform image to be displayed on the PC screen and allows the continuous capture and display to the screen of 2.5 billion samples every second.

The hardware acceleration engine eliminates any concerns about the USB connection or PC processor performance being a bottleneck.

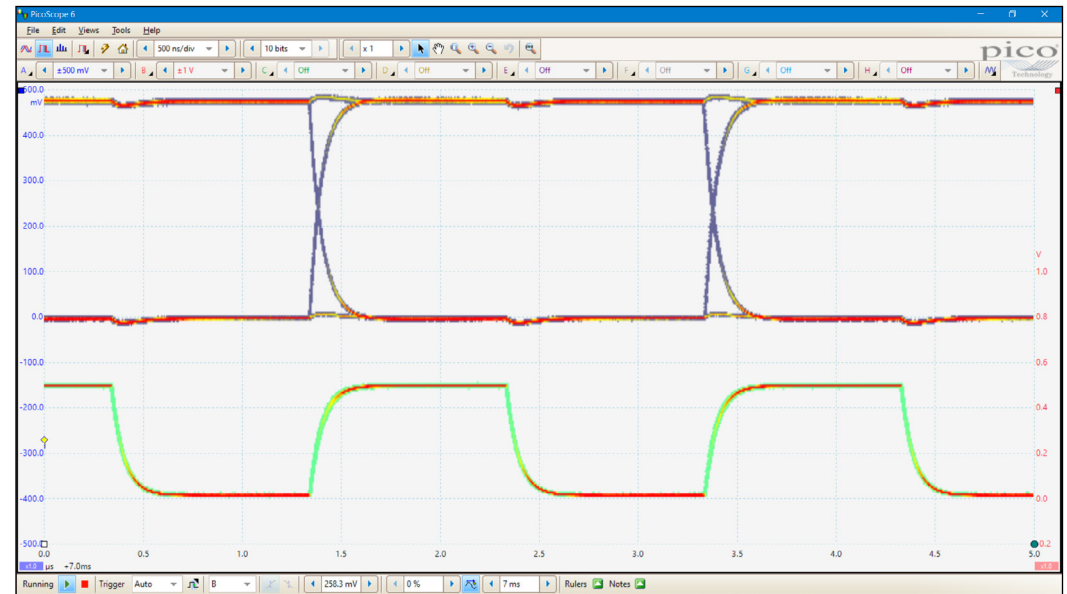

Time-stamping

The PicoScope 6000E Series features hardware-based trigger time-stamping.

Each waveform can be time-stamped with the time in sample intervals from the previous waveform.

Fast trigger rearm times are possible down to 300 ns (typical).

Properties	
Sample interval	800 ps
Sample rate	1.25 GS/s
No. samples	62 (660)
Hardware Resolution	8 bits
Channel	A
Range	±1 V
Coupling	DC
Channel	B
Range	±500 mV
Coupling	DC
Δ First Trigger	3.000μs
Δ Previous Trigger	400.000ns
Capture Date	03/02/2020
Capture Time	12:10:14

Time from first trigger in circular buffer to current trigger

Time from previous trigger to current trigger

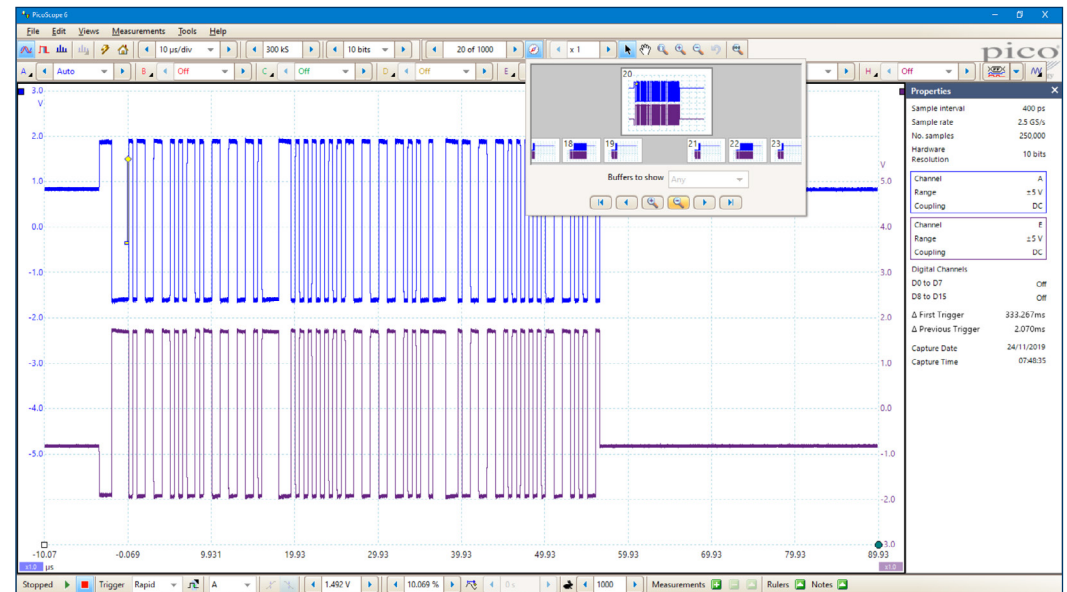

Ultra-high-definition display

PicoScope PC-based instruments use the host computer's display, which is typically larger and of higher resolution than the dedicated displays installed in traditional benchtop oscilloscopes. This allows room for simultaneous display of time- and frequency-domain waveforms, decoded serial bus tables, measurement results with statistics and more.

PicoScope 6 software scales automatically to take full advantage of the improved resolution of larger display sizes, including 4K ultra-high definition models. At 3840 x 2160 resolution—over eight million pixels—PicoScope allows engineers to get more done in less time through split-screen views of multiple channels (or different views of the same channel) from the device under test. As the example shows, the software can even show multiple oscilloscope and spectrum analyzer traces at once.

Large, high-resolution displays really come into their own when viewing high-resolution signals with the PicoScope 6824E and 6424E 8- to 12-bit FlexRes models. With a 4K monitor, PicoScope can display more than ten times the information of some of our competitors' scopes, solving the problem of how to match a big display and features with a small-footprint portable oscilloscope.

PicoScope also supports dual monitors: instrument control and waveforms displayed on the first, and large data sets from serial protocol decoders or DeepMeasure results on the second. The software can be controlled by mouse, touchscreen or keyboard shortcuts.

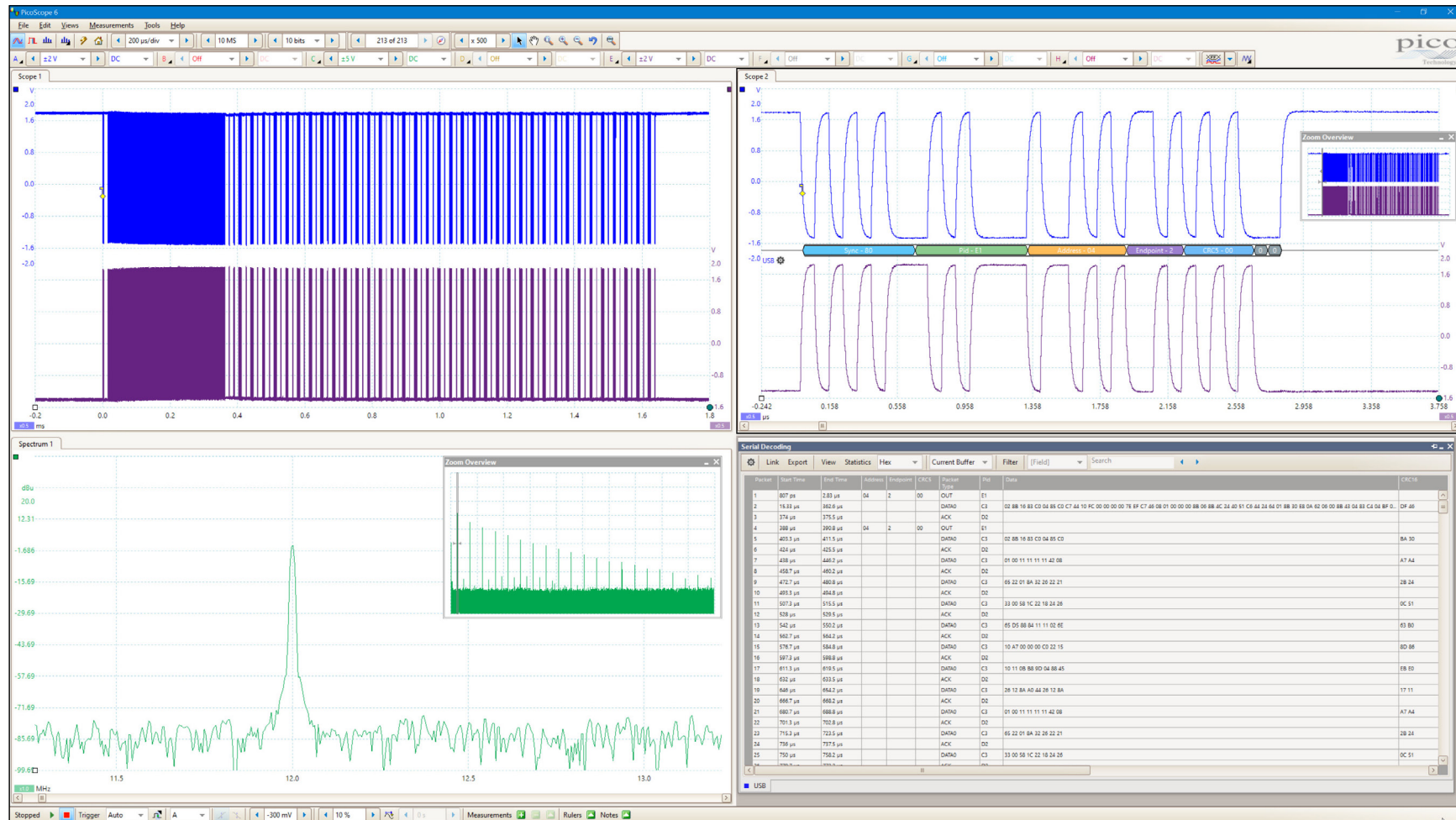

Math channels and filters

With PicoScope 6 you can select simple functions such as addition and inversion, or open the equation editor to create complex functions involving filters (lowpass, highpass, bandpass and bandstop filters), trigonometry, exponentials, logarithms, statistics, integrals and derivatives.

Display up to eight real or calculated channels in each scope view. If you run out of space, just open another scope view and add more. You can also use math channels to reveal new details in complex signals, for example graphing the changing duty cycle or frequency of your signal over time.

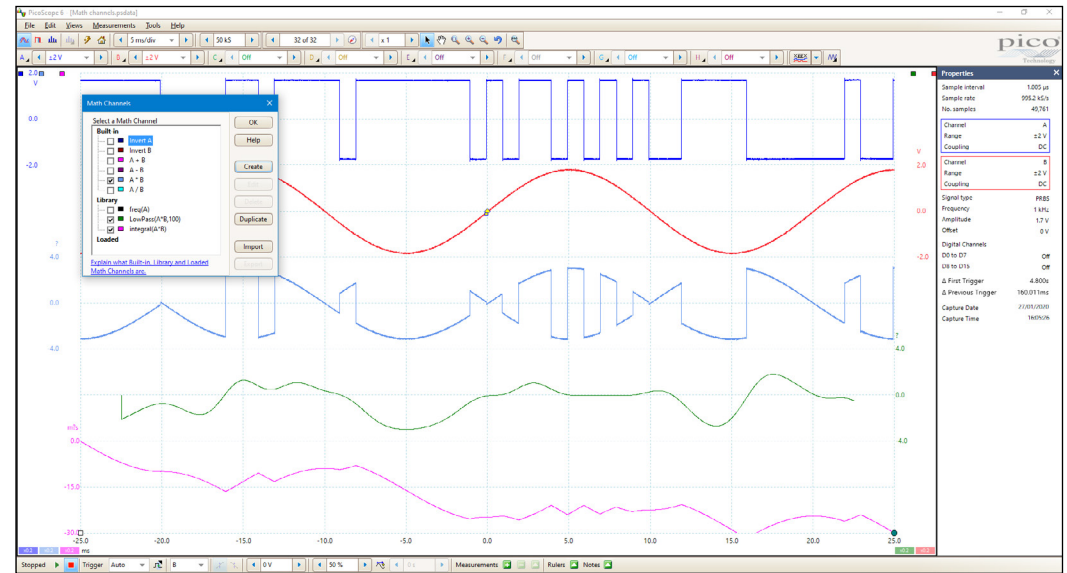

Custom probes in PicoScope oscilloscope software

The custom probes feature allows you to correct for gain, attenuation, offsets and nonlinearities in probes, sensors or transducers that you connect to the oscilloscope. This could be used to scale the output of a current probe so that it correctly displays amperes. A more advanced use would be to scale the output of a nonlinear temperature sensor using the table lookup function.

Definitions for standard Pico-supplied oscilloscope probes and current clamps are included. User-created probes may be saved for later use.

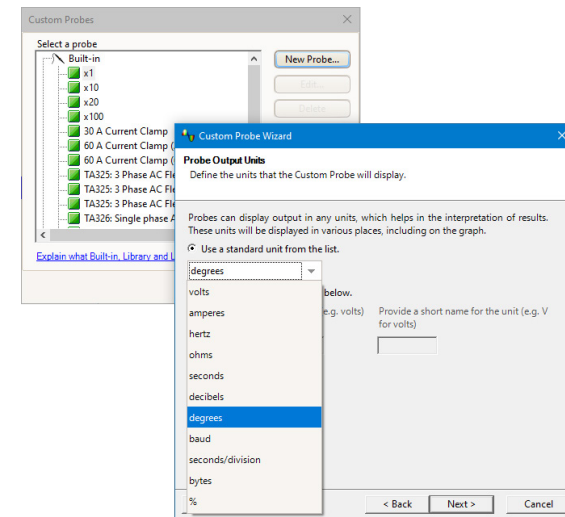

PicoSDK® - write your own apps

Our free software development kit, PicoSDK, allows you to write your own software and includes drivers for Windows, macOS and Linux. Example code supplied on our [GitHub organization page](#) shows how to interface to third-party software packages such as National Instruments LabVIEW and MathWorks MATLAB.

Among other features, the drivers support data streaming, a mode that captures continuous gap-free data directly to your PC or host computer at rates of over 300 MS/s, so you are not limited by the size of your scope's capture memory. Sampling rates in streaming mode are subject to PC specifications and application loading.

There is also an active community of PicoScope users who share both code and whole applications on our [Test and Measurement Forum](#) and the [PicoApps](#) section of the website. The Frequency Response Analyzer shown here is a popular application on the forum.

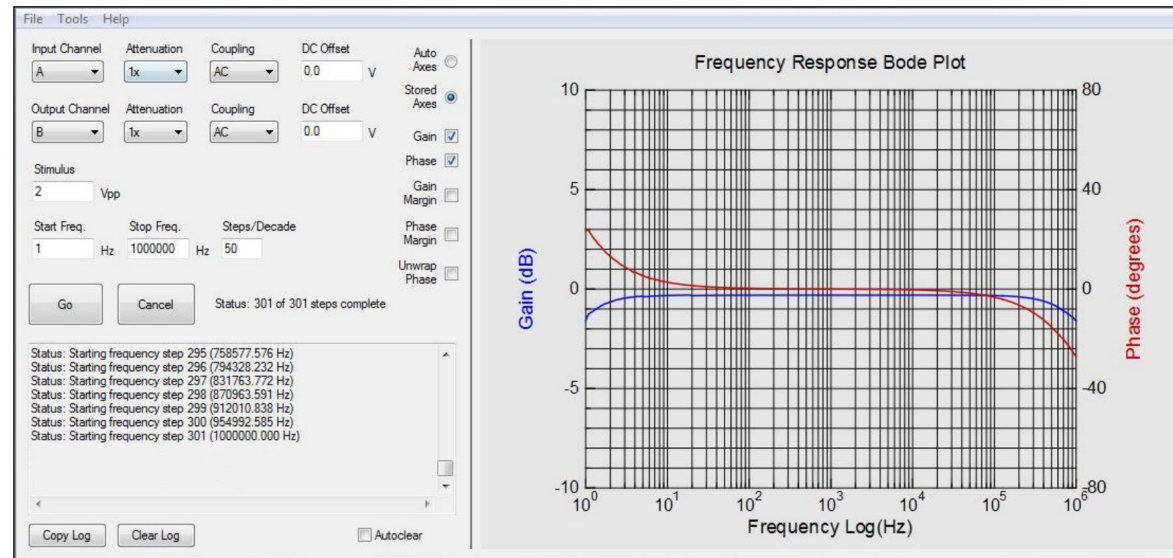

```
ScopeSettingsPropTree.clear();
wstring appVersionStringW = wstring_convert<codecvt_utf8<wchar_t>>().from_bytes(appVersionString);
ScopeSettingsPropTree.put( L"appVersion", appVersionStringW );
ScopeSettingsPropTree.put( L"picoScope.inputChannel.name", L"A" );
ScopeSettingsPropTree.put( L"picoScope.inputChannel.attenuation", ATTEN_1X );
ScopeSettingsPropTree.put( L"picoScope.inputChannel.coupling", PS_AC );
ScopeSettingsPropTree.put( L"picoScope.inputChannel.dcOffset", L"0.0" );
ScopeSettingsPropTree.put( L"picoScope.inputChannel.startingRange", -1 ); // Base on stimulus
ScopeSettingsPropTree.put( L"picoScope.outputChannel.name", L"B" );
ScopeSettingsPropTree.put( L"picoScope.outputChannel.attenuation", ATTEN_1X );
ScopeSettingsPropTree.put( L"picoScope.outputChannel.coupling", PS_AC );
ScopeSettingsPropTree.put( L"picoScope.outputChannel.dcOffset", L"0.0" );
ScopeSettingsPropTree.put( L"picoScope.outputChannel.startingRange", pScope->GetMinRange(PS_AC) );

midSigGenVpp = floor((pScope->GetMinFuncGenVpp() + pScope->GetMaxFuncGenVpp()) / 2.0);

stimulusVppSS << fixed << setprecision(1) << midSigGenVpp;
maxStimulusVppSS << fixed << setprecision(1) << pScope->GetMaxFuncGenVpp();
startFreqSS << fixed << setprecision(1) << (max(1.0, pScope->GetMinFuncGenFreq())); // Make frequency at least 1.0 since 0.0 (DC) makes no sense for FRA
stopFreqSS << fixed << setprecision(1) << (pScope->GetMaxFuncGenFreq());
```

Copyright © 2014-2017 Aaron Hexamer. Distributed under GNU GPL3.

Optional accessories

TA369 MSO pod

The PicoScope 6000E Series can be upgraded to MSO capability. This consists of a detachable active MSO pod, powered by the scope, with eight permanently attached flying leads terminating in MSO probes for connection to the circuit under test.

The active MSO pods bring the MSO input circuitry closer to the device under test minimizing loading and giving the best possible performance.

The MSO pod connects to either of two digital interface ports on the scope front panel using a 0.5 m digital interface cable. All PicoScope 6000E Series models support the MSO pod.

The innovative single and multi-way ground clips allow fast and flexible connection to all signal and ground pins in a double row header, regardless of where the layout engineer has placed them.

Features:

- 8 digital inputs per pod
- 500 MHz bandwidth, 1 Gb/s
- 5 GS/s sampling on 16 digital channels
- 1 ns minimum pulse width
- Minimal load on the device under test: 101 k Ω || 3.5 pF
- Innovative ground clips for easy connection to 2-row, 2.54 mm-pitch headers
- 8 ground leads and 12 mini test hooks included

An MSO pod spares kit (PQ221) is also available which contains extra 1-way, 4-way and 8-way MSO ground clips and MSO ground leads.

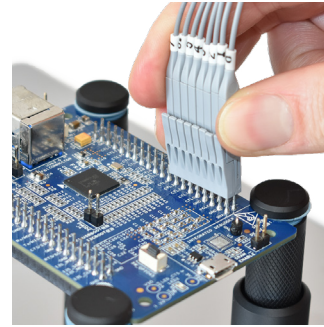
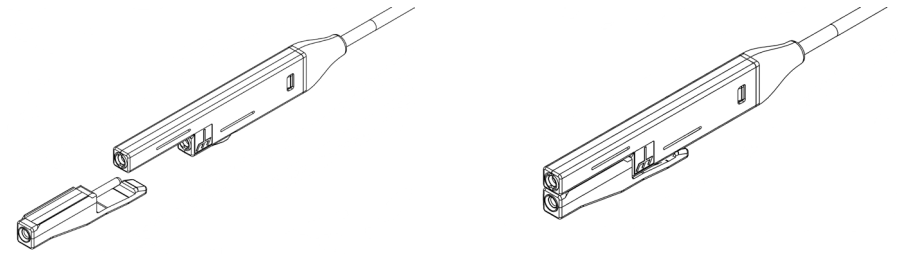

When a header has signal pins on one row and grounds on the other row.

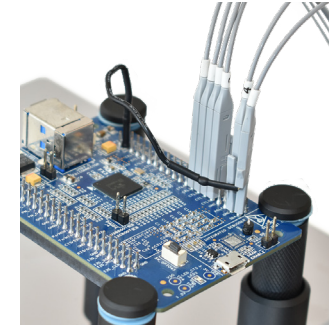

When you find a header with signals situated together and not enough grounds. A ground lead can be used to connect to a remote ground pin on the device under test.

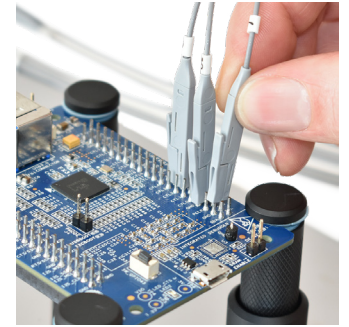

For a header with a mix of non-adjacent and adjacent signal pins. Thank goodness my MSO is so versatile!

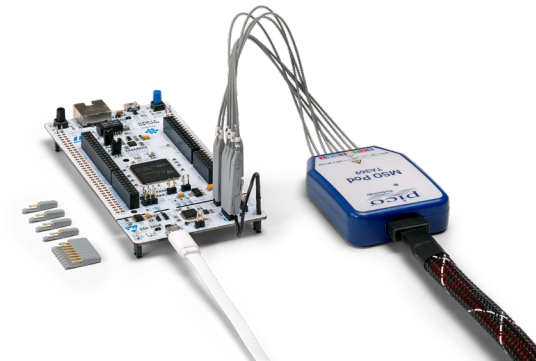

Probe positioning system

The Pico oscilloscope probe positioning system holds your circuit board firmly during soldering, inspection and test.

The kits include flexible probe holders which secure magnetically to the steel base plate. When the probes are installed in the holders they can be positioned to make contact with points of interest on the circuit board and will remain in contact while you make measurements in the PicoScope software.

The large steel base plate is mirror-finished allowing you to see any items such as status LEDs underneath the PCB.



Probe positioning system kit contents:			
Item	PQ215 kit	PQ219 kit	PQ218 kit
PCB holder	4	4	
Base plate, 210 x 297 mm	1	1	
Set of insulation washers for PCB holders	1	1	
Pico probe holder, 2.5 mm	4	8	4
Set of cable holders channels A-D	1	1	1
Set of cable holders channels E-H	1	1	1
P2056 500 MHz 10:1 passive BNC probe		4	
	If you already own a 4- or 8-channel scope with four probes, this kit is the ideal add-on.	Upgrade your 8-channel scope from four to eight probes, and add eight probe holders.	Four extra probe holders.

Passive analog high-impedance probes:

P2056 500 MHz and P2036 300 MHz passive probes are supplied with your scope and are also available separately in single or dual packs. These probes feature a probe-detect readout BNC connector allowing automatic recognition as a 10:1 attenuator by the scope.

Probe connection is confirmed by a notification in PicoScope 6.

Features:

- Up to 500 MHz bandwidth
- 10:1 attenuation
- Trimmed to match the oscilloscope
- Probe-detect readout pin for automatic range scaling

A comprehensive selection of accessories is supplied in the single probe packs and a basic selection in the dual packs. Further accessories are available as listed in the P2056 and P2036 user's guide.



PicoScope 6000E Series specifications

	PicoScope 6824E	PicoScope 6424E	PicoScope 6804E	PicoScope 6404E	PicoScope 6403E
Vertical (analog channels)					
Input channels	8	4	8	4	4
Bandwidth (-3dB)	500 MHz				300 MHz
Rise time	< 850 ps				< 1.3 ns
Bandwidth limit	20 MHz, selectable				
Vertical resolution	8, 10 or 12 bits FlexRes		8 bits fixed		
Enhanced vertical resolution (software)	Up to 4 extra bits beyond ADC resolution				
Input connector	BNC(f)				
Input characteristics	1 M Ω \pm 0.5% 12 pF \pm 1 pF, or 50 Ω \pm 2%. Single-ended.				
Input coupling	1 M Ω AC/DC or 50 Ω DC				
Input sensitivity	2 mV/div to 4 V/div (10 vertical divisions)				
Input ranges (full scale)	1 M Ω ranges: \pm 10 mV, \pm 20 mV, \pm 50 mV, \pm 100 mV, \pm 200 mV, \pm 500 mV, \pm 1 V, \pm 2 V, \pm 5 V, \pm 10V, \pm 20 V 50 Ω ranges: \pm 10 mV, then as above up to \pm 5 V				
DC gain accuracy	\pm (0.5% of signal + 1 LSB)		\pm (1.5% of signal + 1 LSB)		
DC offset accuracy	\pm (1% of full scale + 250 μ V) Offset accuracy can be improved by using the "zero offset" function in PicoScope 6.				
LSB size (quantization step size)	8 bits: < 0.4 % of input range 10 bits: < 0.1 % of input range 12 bits: < 0.025 % of input range		8 bits: < 0.4 % of input range		
Analog offset range (vertical position adjustment)	\pm 1.25 V (10 mV to 1 V ranges) \pm 20 V (2 V to 20 V ranges)				
Analog offset control accuracy	\pm 0.5% of offset setting, additional to DC accuracy above				
Overvoltage protection	1 M Ω ranges: \pm 100 V (DC + AC peak) up to 10 kHz 50 Ω ranges: 5.5 V RMS				
Vertical (digital channels with optional TA369 8-channel MSO pods)					
Input channels	8 channels per MSO pod. Supports up to 2 pods / 16 channels.				
Maximum detectable input frequency	500 MHz (1 Gb/s)				
Minimum detectable pulse width	1 ns				
Input connector (probe tip)	Staggered signal and ground sockets for each channel, to accept 0.64 - 0.89 mm round or 0.64 mm square pin, 2.54 mm pitch				
Input characteristics	101 k Ω \pm 1% 3.5 pF \pm 0.5 pF				
Threshold range and resolution	\pm 8 V in 5 mV steps				
Threshold accuracy	\pm (100 mV + 3% of threshold setting)				
Threshold grouping	PicoScope 6: Two independent threshold controls, one per 8-channel port PicoSDK: Individual threshold for each channel				
Threshold selection	TTL, CMOS, ECL, PECL, user-defined				
Maximum input voltage at probe tip	\pm 40 V up to 10 MHz, derated linearly to \pm 5 V at 500 MHz				
Minimum input voltage swing (at 500 MHz)	400 mV peak to peak				

	PicoScope 6824E	PicoScope 6424E	PicoScope 6804E	PicoScope 6404E	PicoScope 6403E
Hysteresis (at DC)	PicoScope 6: Fixed hysteresis approx. 100 mV. PicoSDK: selectable per port; approx. 50 mV, 100 mV, 200 mV or 400 mV				
Minimum input slew rate	No minimum slew rate requirement				
Horizontal					
Maximum sampling rate (real time, 8-bit mode)					
Up to 2 total analog channels and MSO pods	5 GS/s ^[1]	5 GS/s ^[3]	5 GS/s ^[1]	5 GS/s ^[3]	2.5 GS/s ^[3] (2 analog channels) 5 GS/s (1 or no analog channels)
Up to 4 total analog channels and MSO pods	2.5 GS/s ^[2]	2.5 GS/s	2.5 GS/s ^[2]	2.5 GS/s	1.25 GS/s (3-4 analog channels) 2.5 GS/s ^[3] (2 analog channels)
Up to 8 total analog channels and MSO pods	1.25 GS/s	1.25 GS/s	1.25 GS/s	1.25 GS/s	1.25 GS/s
Over 8 channels and digital ports	625 MS/s	N/A	625 MS/s	N/A	
Maximum sampling rate (real time, 10-bit mode)					
1 analog channel or digital port	5 GS/s	5 GS/s	N/A		
Up to 2 total analog channels and MSO pods	2.5 GS/s ^[2]	2.5 GS/s			
Up to 4 total analog channels and MSO pods	1.25 GS/s	1.25 GS/s			
Up to 8 total analog channels and MSO pods	625 MS/s	625 MS/s			
Over 8 channels and digital ports	312.5 MS/s	N/A			
Maximum sampling rate (real time, 12-bit mode)					
Up to 2 analog channels plus any MSO pods	1.25 GS/s ^[1]	1.25 GS/s ^[3]	N/A		
^[1] No more than one channel from each of ABCD and EFGH ^[2] No more than one channel from each of AB, CD, EF and GH ^[3] No more than one channel from each of AB and CD					
Max. sampling rate, USB 3.0 streaming mode, PicoScope 6 (split between active channels, PC dependent)	~20 MS/s				
Max. sampling rate, USB 3.0 streaming mode, PicoSDK (split between active channels, PC dependent)	~312 MS/s (8-bit mode) ~156 MS/s (10/12-bit modes)		~312 MS/s		
Max. sampling rate to on-device buffer (continuous USB streaming of downsampled data, PicoSDK only, split between enabled channels)	1.25 GS/s (8-bit mode)		N/A		
	625 MS/s (10/12-bit modes)				
Capture memory (shared between active channels)	4 GS (2 GS at 10/12-bit)		2 GS		1 GS

	PicoScope 6824E	PicoScope 6424E	PicoScope 6804E	PicoScope 6404E	PicoScope 6403E
Maximum single capture duration at maximum sampling rate (PicoScope 6)	200 ms				
Maximum single capture duration at maximum sampling rate (PicoSDK)	800 ms (8-bit) 400 ms (10-bit) 1600 ms (12-bit)		400 ms	400 ms	200 ms
Capture memory (continuous streaming)	100 MS in PicoScope software. Buffering using full device memory when using PicoSDK, no limit on total duration of capture.				
Waveform buffer (number of segments)	PicoScope 6: 10 000 PicoSDK: 2 000 000				PicoSDK: 1 000 000
Timebase ranges	1 ns/div to 5000 s/div				
Initial timebase accuracy	±2 ppm				
Timebase drift	±1 ppm/year				
ADC sampling	Simultaneous sampling on all enabled analog and digital channels				
External reference clock					
Input characteristics	Hi-Z, AC coupled (> 1 kΩ at 10 MHz)				
Input frequency range	10 MHz ±50 ppm				
Input connector	Rear-panel BNC, dedicated				
Input level	200 mV to 3.3 V peak to peak				
Overvoltage protection	±5 V peak max				
Dynamic performance (typical)					
Crosstalk	±10 mV to ±1 V ranges: better than 1200:1 up to full bandwidth (equal voltage ranges) ±2 V to ±20 V ranges: better than 300:1 up to full bandwidth (equal voltage ranges)				
Harmonic distortion, 8-bit mode	-50 dB at 1 MHz full scale				
Harmonic distortion, 10/12-bit mode	-60 dB at 1 MHz full scale			N/A	
SFDR, 8-bit mode	> 50 dB on ±50 mV to ±20 V ranges				
SFDR, 10/12-bit mode	> 60 dB on ±50 mV to ±20 V ranges			N/A	
Noise, 8-bit mode	< 200 μV RMS on most sensitive range				
Noise, 10/12-bit mode	< 150 μV RMS on most sensitive range			N/A	
Linearity, 8-bit mode	< 2 LSB				
Linearity, 10-bit mode	< 4 LSB			N/A	
Bandwidth flatness	(+0.3 dB, -3 dB) from DC to full bandwidth				
Low frequency flatness	< ±3% (or ±0.3 dB) from DC to 1 MHz				
Triggering					
Source	Any analog channel, AUX trigger, plus digital ports with optional TA369 MSO pods				
Trigger modes	None, auto, repeat, single, rapid (segmented memory)				
Advanced trigger types (analog channels)	Edge, window, pulse width, window pulse width, level dropout, window dropout, interval, runt, logic Logic allows arbitrary combinations of up to 4 analog channels or MSO ports				
Trigger sensitivity (analog channels)	Digital triggering provides 1 LSB accuracy up to full bandwidth of scope				
Advanced trigger types (digital inputs)	With optional MSO pods: Edge, pulse width, dropout, interval, pattern, logic (mixed signal)				

	PicoScope 6824E	PicoScope 6424E	PicoScope 6804E	PicoScope 6404E	PicoScope 6403E
Maximum pre-trigger capture	100% of capture size				
Maximum post-trigger delay	PicoScope 6: up to 0.8 s at fastest timebase PicoSDK: > 10 ¹² sample intervals, settable in 1 sample steps (delay range at fastest sample rate of > 200 s in 200 ps steps)				
Rapid trigger mode rearm time	700 ns max, 300 ns typical (single channel, 5 GS/s)				
Maximum trigger rate	PicoScope 6: 10 000 waveforms in 3 ms; PicoSDK: 1 million waveforms in 0.3 s				
Trigger time-stamping	Each waveform is timestamped with a resolution of one sample interval relative to the previous waveform. Time resets when any settings are changed.				
Auxiliary trigger I/O					
Connector type	Rear-panel BNC				
Trigger types (triggering scope)	Edge, pulse width, dropout, interval, logic				
Input bandwidth	> 10 MHz				
Input characteristics	2.5 V CMOS Hi-Z input, DC coupled				
Threshold range	Fixed threshold, 1.25 V nominal				
Hysteresis	1 V max ($V_{IH} < 1.75V$, $V_{IL} > 0.75V$)				
Overvoltage protection	±20 V peak max				
Function generator					
Standard output signals	Sine, square, triangle, DC voltage, ramp up, ramp down, sinc, Gaussian, half-sine				
Standard signal frequency	Sine: 100 µHz to 50 MHz; Square: 100 µHz to 50 MHz; Other waves: 100 µHz to 1 MHz				
Output frequency accuracy	Oscilloscope timebase accuracy ± output frequency resolution				
Output frequency resolution	0.002 ppm				
Sweep modes	Up, down, dual with selectable start/stop frequencies and increments				
Sweep frequency range	Sine / square waves: 0.075 Hz to 50 MHz Other waves: 0.075 Hz to 1 MHz Swept frequencies down to 100 µHz are possible using PicoSDK with some restrictions				
Sweep frequency resolution	In PicoScope 6 software: 0.075 Hz. Sweep frequency resolution down to 100 µHz is possible via PicoSDK with some restrictions				
Triggering	Free-run, or from 1 to 1 billion counted waveform cycles or frequency sweeps. Triggered from scope trigger or manually.				
Gating	Software controlled gating of waveform output				
Pseudorandom output signals	White noise, selectable amplitude and offset within output voltage range Pseudorandom binary sequence (PRBS), selectable high and low levels within output voltage range, selectable bit rate up to 50 Mb/s				
Output voltage range	±5 V into open circuit; ±2.5 V into 50 Ω				
Output voltage adjustment	Signal amplitude and offset adjustable in < 1 mV steps within overall range				
DC accuracy	±(0.5% of output voltage + 20 mV)				
Amplitude flatness	< 2.0 dB to 50 MHz (sine wave into 50 Ω) < 0.5 dB to 50 MHz (square) < 1.0 dB to 1 MHz (other waveforms)				
Analog filters	50 MHz selectable filter (5-pole, 30 dB/octave)				
SFDR	70 dB (10 kHz 1 V peak to peak sine into 50 Ω)				

	PicoScope 6824E	PicoScope 6424E	PicoScope 6804E	PicoScope 6404E	PicoScope 6403E
Output noise	< 700 μ V RMS (DC output, filter enabled, into 50 Ω)				
Output resistance	50 Ω \pm 3%				
Connector type	Rear-panel BNC				
Overvoltage protection	\pm 20 V peak max				
Arbitrary waveform generator					
Update rate	Variable from < 1 S/s to 200 MS/s with < 0.02 ppm resolution				
Buffer size	40 kS				
Vertical resolution	14 bits (output step size < 1 mV)				
Bandwidth	No filter: 100 MHz Filtered: 50 MHz				
Rise time (10% to 90%)	No filter: 3.5 ns Filtered: 6 ns				
Sweep modes, triggering, frequency accuracy and resolution, voltage range and accuracy and output characteristics as for function generator.					
Probe support					
Active probe interface	Active probe interface on four channels supporting A6000 Series active probes. Probe interface supplies power and controls the active probe.				
Probe detection	Automatic detection of P2036 (300 MHz) and P2056 (500 MHz) 10:1 oscilloscope probes				
Probe compensation pin	1 kHz, 2 V peak to peak square wave, 600 Ω				
Probe compensation pin rise time	< 50 ns				
Spectrum analyzer					
Frequency range	DC to 500 MHz				DC to 300 MHz
Display modes	Magnitude, average, peak hold				
Y axis	Logarithmic (dBV, dBu, dBm, arbitrary dB) or linear (volts)				
X axis	Linear or logarithmic				
Windowing functions	Rectangular, Gaussian, triangular, Blackman, Blackman-Harris, Hamming, Hann, flat-top				
Number of FFT points	Selectable from 128 to 1 million in powers of 2				
Math channels					
Functions	-x, x+y, x-y, x*y, x/y, x^y, sqrt, exp, ln, log, abs, norm, sign, sin, cos, tan, arcsin, arccos, arctan, sinh, cosh, tanh, delay, average, frequency, derivative, integral, min, max, peak, duty, highpass, lowpass, bandpass, bandstop, coupler				
Operands	A to H (input channels), T (time), reference waveforms, pi, 1D0 to 2D7 (digital channels), constants				
Automatic measurements					
Scope mode	AC RMS, true RMS, frequency, cycle time, duty cycle, DC average, falling rate, rising rate, low pulse width, high pulse width, fall time, rise time, minimum, maximum, peak to peak				
Spectrum mode	Frequency at peak, amplitude at peak, average amplitude at peak, total power, THD %, THD dB, THD+N, SFDR, SINAD, SNR, IMD				
Statistics	Minimum, maximum, average, standard deviation				
DeepMeasure™					
Parameters	Cycle number, cycle time, frequency, low pulse width, high pulse width, duty cycle (high), duty cycle (low), rise time, fall time, undershoot, overshoot, max. voltage, min. voltage, voltage peak to peak, start time, end time				

	PicoScope 6824E	PicoScope 6424E	PicoScope 6804E	PicoScope 6404E	PicoScope 6403E
Serial decoding					
Protocols	1-Wire, ARINC 429, BroadR-Reach, CAN & CAN FD, DALI, DCC, DMX512, Ethernet 10Base-T and 100Base-TX, FlexRay, I ² C, I ² S, LIN, PS/2, Manchester, Modbus, SENT, SPI, UART (RS-232 / RS-422 / RS-485), and USB 1.1				
Mask limit testing					
Statistics	Pass/fail, failure count, total count				
Mask creation	User-drawn, table entry, auto-generated from waveform or imported from file				
Display					
Interpolation	Linear or sin(x)/x				
Persistence modes	Digital color, analog intensity, custom, fast				
Languages	Chinese (simplified), Chinese (traditional), Czech, Danish, Dutch, English, Finnish, French, German, Greek, Hungarian, Italian, Japanese, Korean, Norwegian, Polish, Portuguese, Romanian, Russian, Spanish, Swedish, Turkish				

	PicoScope 6824E	PicoScope 6424E	PicoScope 6804E	PicoScope 6404E	PicoScope 6403E
General specifications					
PC connectivity	USB 3.0 SuperSpeed (USB 2.0 compatible)				
PC connector type	USB Type B				
Power requirement	12 V DC from supplied PS016 PSU. Up to 7 A including powered accessories.				
Ground terminal	Functional ground terminal accepting wire or 4 mm plug, rear-panel				
Dimensions	245 x 192 x 61.5 mm				
Weight	2.2 kg (scope only) 5.6 kg (in carry case with PSU and cables)				
Temperature range	Operating: 0 to 40 °C For quoted accuracy after 20 minutes warm-up: 15 to 30 °C Storage: -20 to +60 °C				
Humidity range	Operating: 5% to 80% RH non-condensing Storage: 5% to 95% RH non-condensing				
Altitude range	Up to 2000 m				
Pollution degree	EN 61010 pollution degree 2: "only nonconductive pollution occurs except that occasionally a temporary conductivity caused by condensation is expected"				
IP rating	IP20				
Safety compliance	Designed to EN 61010-1:2010				
EMC compliance	Tested to EN 61326-1:2013 and FCC Part 15 Subpart B				
Environmental compliance	RoHS & WEEE compliance				
Software	PicoScope 6: All supported Windows operating systems. Beta software also available for 64-bit Linux and macOS. PicoSDK: All supported Windows operating systems. Drivers also available for 64-bit Linux and macOS. Users writing their own apps can find example programs for all platforms on the Pico Technology organization page on GitHub .				
PC requirements	Processor, memory and disk space: as required by the operating system Ports: USB 3.0 (recommended) or 2.0 (compatible)				
Warranty	5 years				
MSO pod dimensions					
MSO digital interface cable length	500 mm (scope to pod)				
MSO probe flying lead length	225 mm (pod to probe tip)				
MSO pod size	75 x 55 x 18.2 mm				
MSO probe size	34.5 x 2.5 x 6.7 mm (including ground clip)				

Optional accessories

Order code	Description	USD*	EUR*	GBP*
MSO pods				
TA369	8-channel MSO Pod for PicoScope 6000E Series	709	599	499
MSO pod replacement accessories				
PQ221	MSO pod spares kit	41	35	29
TA139	MSO grabbers, pack of 12	30	25	21
TA365	MSO digital interface cable	35	20	25
Probe positioning system				
TA102	Two-footed probe holder	25	21	18
PQ215	Probe holder and PCB holder kit, no probes	369	309	259
PQ219	8-channel probe holder upgrade kit with 4 probes for PicoScope 6000E Series	1295	1095	909
PQ218	4 additional probe holders	245	205	169
Passive probes				
TA437	P2056 500 MHz 10:1 passive probe	235	199	165
TA480	P2056 500 MHz 10:1 passive probe dual pack	389	329	269
TA436	P2036 300 MHz 10:1 passive probe	199	169	139
TA479	P2036 300 MHz 10:1 passive probe dual pack	309	259	219
High-impedance active probe				
TA112	TETRIS 1000 1 GHz high-impedance active probe, standard BNC connector	989	839	679
High-voltage differential probes				
TA042	100 MHz 1400 V differential oscilloscope probe 100:1/1000:1, standard BNC connector	609	519	419
TA043	100 MHz 700 V differential oscilloscope probe 10:1/100:1, standard BNC connector	659	559	459
Power supply				
PQ247	12 V 7 A PS016 PSU, IEC input, DIN output and supplied with 4 IEC mains cables (UK, EU, US and Australia/China)	93	79	65

PicoScope 6000E Series oscilloscope pack contents

- PicoScope 6000E Series PC oscilloscope
- P2056 500 MHz 10:1 passive probes (4) (supplied with the PicoScope 6824E, 6424E, 6804E and 6404E)
- P2036 300 MHz 10:1 passive probes (4) (supplied with the PicoScope 6403E)
- Quick start guide
- 12 V power supply, universal input
- Localized IEC mains lead
- USB cable, 1.8 m
- Storage / carry case



TA369 MSO pod pack contents

- TA369 8-channel MSO pod
- MSO test hooks (pack of 12)
- MSO ground lead (8)
- MSO ground clip 1-way (8)
- MSO ground clip 4-way
- MSO ground clip 8-way
- MSO digital interface cable
- Storage / carry case



MSO pod spares kit contents

A spares kit is available containing the following items:

- MSO ground clip 1-way (8)
- MSO ground clip 4-way
- MSO ground clip 8-way
- MSO ground lead (8)



PicoScope 6000E Series ordering information

Order code	Description	Bandwidth (MHz)	Channels	Resolution (bits)	Memory (GS)	USD*	EUR*	GBP*
PQ198	PicoScope 6824E	500	8	8 to 12	4	14 245	12 095	9 995
PQ201	PicoScope 6424E	500	4	8 to 12	4	8 725	7 415	6 125
PQ197	PicoScope 6804E	500	8	8	2	11 395	9 675	7 995
PQ200	PicoScope 6404E	500	4	8	2	7 305	6 205	5 125
PQ199	PicoScope 6403E	300	4	8	1	4 865	4 135	3 415

Calibration service

Order code	Description	USD*	EUR*	GBP*
CC051	Calibration certificate for PicoScope 6000E Series oscilloscopes	179	159	139

* Prices correct at time of publication. Sales taxes not included. Please contact Pico Technology for the latest prices before ordering.

More devices from Pico Technology...



PicoLog ADC-20/24
High-resolution and high-accuracy voltage input data loggers



PicoScope 9400 SXRTO
Sampler-extended real-time oscilloscopes 5 to 16 GHz



PicoVNA
Low-cost, professional-grade 6 GHz vector network analyzer for both lab and field use



PicoSource AS108
8 GHz agile USB controlled vector modulating signal synthesizer

United Kingdom global headquarters

Pico Technology
James House
Colmworth Business Park
St. Neots
Cambridgeshire
PE19 8YP
United Kingdom

www.picotech.com

+44 (0) 1480 396 395

sales@picotech.com

North America regional office

Pico Technology
320 N Glenwood Blvd
Tyler
TX 75702
United States

www.picotech.com

+1 800 591 2796

sales@picotech.com

Asia-Pacific regional office

Pico Technology
Room 2252, 22/F, Centro
568 Hengfeng Road
Zhabei District
Shanghai 200070
PR China

www.picotech.com

+86 21 2226-5152

pico.asia-pacific@picotech.com

Errors and omissions excepted.

Pico Technology, PicoScope, PicoSDK, and FlexRes are internationally registered trademarks of Pico Technology Ltd. LabVIEW is a trademark of National Instruments Corporation. Linux is the registered trademark of Linus Torvalds, registered in the U.S. and other countries. macOS is a trademark of Apple Inc., registered in the U.S. and other countries. MATLAB is a registered trademark of The MathWorks, Inc. Windows is a registered trademark of Microsoft Corporation in the United States and other countries. MM105.en-4 Copyright © 2020 Pico Technology Ltd. All rights reserved.

www.picotech.com



Pico Technology



@LifeAtPico



@picotechnologyltd



Pico Technology



@picotech